Design Example Report

Title	<i>45 W USB PD 3.0 with 3.3 V - 16 V PPS Power Supply Using InnoSwitch™ 3-Pro INN3368C-H301 and Weltrend WT6635P</i>
Specification	85 VAC – 264 VAC Input; 5 V, 3 A; 9 V, 3 A; 15 V, 3 A; 20 V, 2.25 A 3.3V – 16V PPS Outputs
Application	Mobile Phone Charger
Author	Applications Engineering Department
Document Number	DER-702
Date	October 5, 2018
Revision	1.2

Summary and Features

- InnoSwitch3-Pro - digitally controllable CV/CC QR flyback switcher IC with integrated high-voltage MOSFET, synchronous rectification and FluxLink™ feedback
 - I²C interface enables low pin count USB PD controller (10 pin)
 - Sophisticated telemetry and comprehensive protection features
- USB PD 3.0 with PPS highly optimized low pin count USB PD controller WT6635P
- All the benefits of secondary-side control with the simplicity of primary-side regulation
 - Insensitive to transformer variation
- Meets DOE6 and CoC V5 2016 efficiency requirement (>1% efficiency margin)
- Micro stepping of voltages and CC thresholds in compliance with PPS protocol
- Output overvoltage and overcurrent protection
- <30 mW no-load input power
- Integrated thermal protection
- 20 mV voltage step / 50 mA current step in PPS mode

Power Integrations

5245 Hellyer Avenue, San Jose, CA 95138 USA.
Tel: +1 408 414 9200 Fax: +1 408 414 9201
www.power.com

PATENT INFORMATION

The products and applications illustrated herein (including transformer construction and circuits external to the products) may be covered by one or more U.S. and foreign patents, or potentially by pending U.S. and foreign patent applications assigned to Power Integrations. A complete list of Power Integrations' patents may be found at www.powerint.com. Power Integrations grants its customers a license under certain patent rights as set forth at <https://www.power.com/company/intellectual-property-licensing/>.

**Power Integrations, Inc.**Tel: +1 408 414 9200 Fax: +1 408 414 9201
www.power.com

Table of Contents

1	Introduction	6
2	Power Supply Specification	9
3	Schematics	10
3.1	Schematic [Part A - Mother Board]	10
3.2	Schematic [Part B - Daughter Board]	10
4	Circuit Description	11
4.1	Mother Board Circuit Description.....	11
4.1.1	Input Rectifier and Filter.....	11
4.1.2	InnoSwitch3-Pro IC Primary.....	11
4.1.3	InnoSwitch3-Pro IC Secondary.....	12
4.2	Daughter Board Circuit Description	13
4.2.1	USB Type-C and PD Interface	13
5	PCB Layout	14
5.1	PCB Modifications	16
6	Bill of Materials – Mother Board.....	18
7	Bill of Materials – Daughter Board	19
8	Transformer Specification	20
8.1	Electrical Diagram.....	20
8.2	Electrical Specifications	20
8.3	Material List	20
8.4	Transformer Build Diagram	21
8.5	Transformer Construction.....	21
8.6	Winding Illustrations	22
9	Common Mode Choke Specifications.....	29
9.1	34 mH Common Mode Choke (L1)	29
9.1.1	Electrical Diagram	29
9.1.2	Electrical Specifications.....	29
9.1.3	Material List.....	29
9.1.4	Illustrations	30
9.1.5	Winding Instructions	30
10	Transformer Design Spreadsheet	31
11	Performance Data	36
11.1	No-Load Input Power at 5 V Output.....	36
11.1.1	Average Efficiency Requirements	37
11.1.2	Average Efficiency Summary.....	37
11.2	Average Efficiency (On Board) and 10% Load at 115 VAC Input.....	38
11.2.1	3.3 V Output.....	38
11.2.2	5.0 V Output.....	38
11.2.3	9.0 V Output.....	38
11.2.4	15.0 V Output.....	38
11.2.5	20.0 V Output.....	39
11.3	Average Efficiency (On Board) at 230 VAC Input and 10% Load.....	39

11.3.1	3.3 V Output.....	39
11.3.2	5.0 V Output.....	39
11.3.3	9.0 V Output.....	39
11.3.4	15.0 V Output.....	40
11.3.5	20.0 V Output.....	40
11.4	Efficiency Across Load.....	41
11.4.1	5 V Output	41
11.4.2	9 V Output	42
11.4.3	15 V Output.....	43
11.4.4	20 V Output.....	44
11.5	Line Regulation (On Board)	45
11.5.1	5.0 V Output.....	45
11.5.2	9.0 V Output.....	46
11.5.3	15.0 V Output.....	47
11.5.4	20.0 V Output.....	48
11.6	Load Regulation (On Board)	49
11.6.1	5.0 V Output.....	49
11.6.2	9.0 V Output.....	50
11.6.3	15.0 V Output.....	51
11.6.4	20.0 V Output.....	52
12	Thermal Performance in Open Case	53
12.1	5 V, 3 A	53
12.1.1	85 VAC Input.....	53
12.1.2	265 VAC Input	54
12.2	9 V, 3 A	55
12.2.1	85 VAC Input.....	55
12.2.2	265 VAC Input	55
12.3	15 V, 3 A.....	56
12.3.1	85 VAC Input.....	56
12.3.2	265 VAC Input	56
12.4	20 V, 2.25 A.....	57
12.4.1	85 VAC Input.....	57
12.4.2	265 VAC Input	57
13	Waveforms	58
13.1	Load Transient Response	58
13.2	Switching Waveforms.....	66
13.2.1	Primary Drain Voltage and Current.....	66
13.2.2	SR FET Voltage	68
13.3	Start-up	70
13.4	Output Ripple Measurements.....	71
13.4.1	Ripple Measurement Technique	71
14	CV/CC Profile	74
15	Voltage and Current Step Test using Quadramax and Total Phase Analyzer	75



16 Conducted EMI77

16.1 Floating Output (QPK / AV)77

16.1.1 5 V, 3 A.....77

16.1.2 9 V, 3 A.....77

16.1.3 15 V, 3 A.....78

16.1.4 20 V, 2.25 A78

17 Revision History79

Important Note:

Although this board is designed to satisfy safety isolation requirements, the engineering prototype has not been agency approved. Therefore, all testing should be performed using an isolation transformer to provide the AC input to the prototype board.



1 Introduction

This document is an engineering report describing a 5 V / 3 A, 9 V / 3 A, 15 V / 3 A, 20 V 2.25 A USB PD PPS power supply. This power supply uses InnoSwitch3-Pro INN3368C IC and Weltrend WT6635P USB PD controller. This design shows the high power density and efficiency that is possible due to the high level of integration of the InnoSwitch3-Pro controller providing exceptional performance.

This document contains the power supply specification, schematic, bill of materials, transformer documentation, printed circuit layout, and performance data

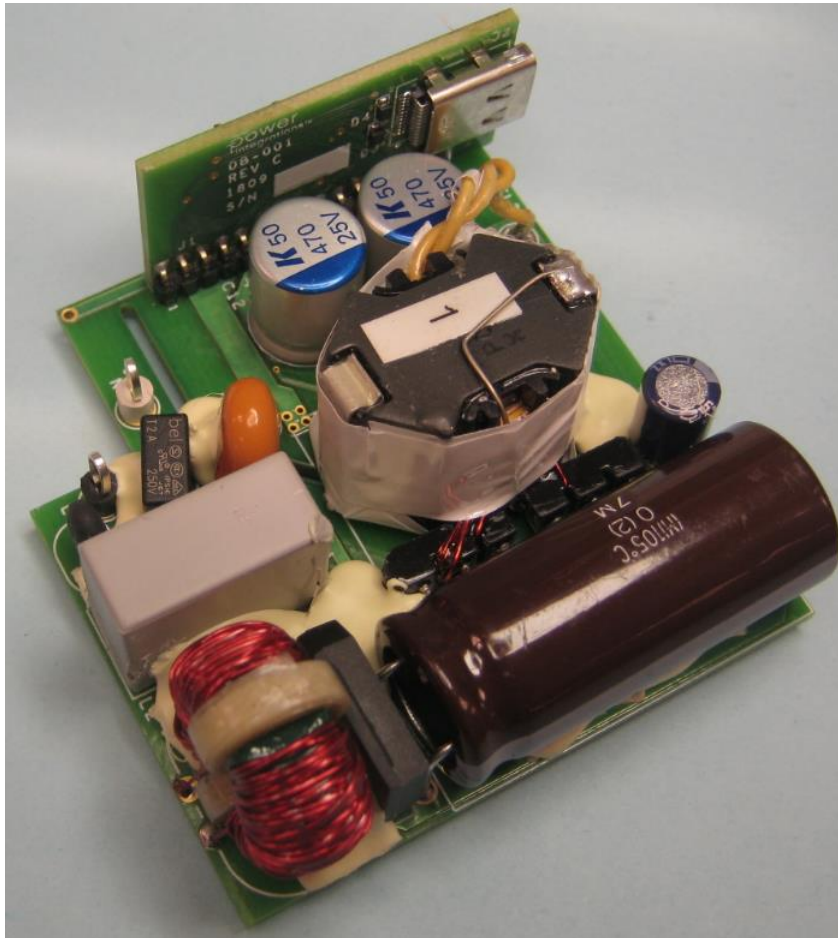

Figure 1 – Populated Circuit Board Photograph, Entire Assembly.



Figure 2 – Populated Circuit Board Photograph - Top.

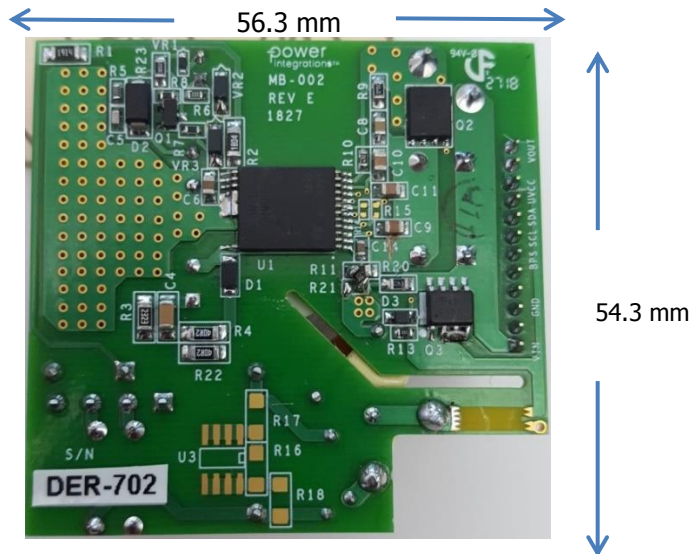

Figure 3 – Populated Circuit Board Photograph - Bottom.

Maximum total height:
23.56 mm

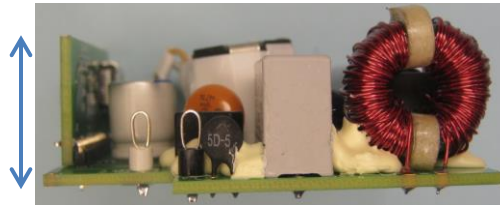

Figure 4 – Populated Circuit Board Photograph (Side View)



Figure 5 – Populated Circuit Board Photograph, Daughter Board [Front and Rear].

2 Power Supply Specification

The table below represents the minimum acceptable performance of the design. Actual performance is listed in the results section.

Description	Symbol	Min	Typ	Max	Units	Comment
Input						
Voltage	V_{IN}	85		264	VAC	2 Wire – no P.E.
Frequency	f_{LINE}	47	50/60	64	Hz	
No-load Input Power (85 VAC)			34	40	mW	Measured at 85 VAC.
Output						
Output Voltage	V_{OUT}		5.0		V	$\pm 3\%$
Output Ripple Voltage	V_{RIPPLE}			150	mV	At End of Cable. Cable Needs a Resistance of 100 m Ω . 20 MHz Bandwidth.
Output Current	I_{OUT}		3.0		A	
Efficiency	η	86.5			%	
Continuous Output Power	P_{OUT}			15	W	
Output						
Output Voltage	V_{OUT}		9.0		V	$\pm 3\%$
Output Ripple Voltage	V_{RIPPLE}			150	mV	At End of Cable. Cable Needs a Resistance of 100 m Ω . 20 MHz Bandwidth.
Output Current	I_{OUT}		3.0		A	
Efficiency	η	88			%	
Continuous Output Power	P_{OUT}			27	W	
Output						
Output Voltage	V_{OUT}		15.0		V	$\pm 3\%$
Output Ripple Voltage	V_{RIPPLE}			150	mV	At End of Cable. Cable Needs a Resistance of 100 m Ω . 20 MHz Bandwidth.
Output Current	I_{OUT}		3.0		A	
Efficiency	η	87.3			%	
Continuous Output Power	P_{OUT}			45	W	
Output						
Output Voltage	V_{OUT}		20.0		V	$\pm 3\%$
Output Ripple Voltage	V_{RIPPLE}			200	mV	At End of Cable. Cable Needs a Resistance of 100 m Ω . 20 MHz Bandwidth.
Output Current	I_{OUT}		2.25		A	
Efficiency	η	87.3			%	
Continuous Output Power	P_{OUT}			45	W	
Maximum Programmable Output Voltage	V_{OUT}	21			V	APDO Maximum Voltage
Minimum Programmable Output Voltage	V_{OUT}	3.3			V	APDO Minimum Voltage
PPS Voltage Step	V_{OUT}		20		mV	PPS Voltage Step (USB PD 3.0)
PPS Current Step	I_{OUT}		50		mA	PPS current Step (USB PD 3.0)
Conducted EMI		Meets CISPR22B / EN55022B				
Ambient Temperature	T_{AMB}	0		40	$^{\circ}\text{C}$	Free Convection, Sea Level.

Note: To use this design for a charger/adaptor, circuit board would need to be modified depending on shape and form factor of the housing. ESD and Line surge performance should be evaluated and layout adjusted to meet the target specification.

3 Schematics

3.1 Schematic [Part A - Mother Board]

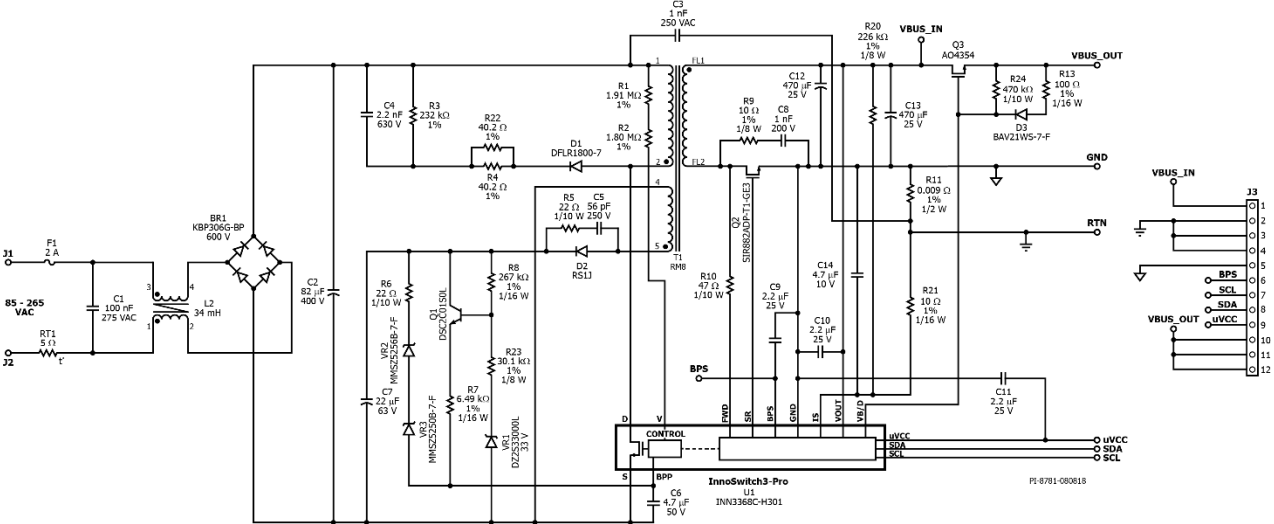

Figure 6 – Schematic of Mother Board.

3.2 Schematic [Part B - Daughter Board]

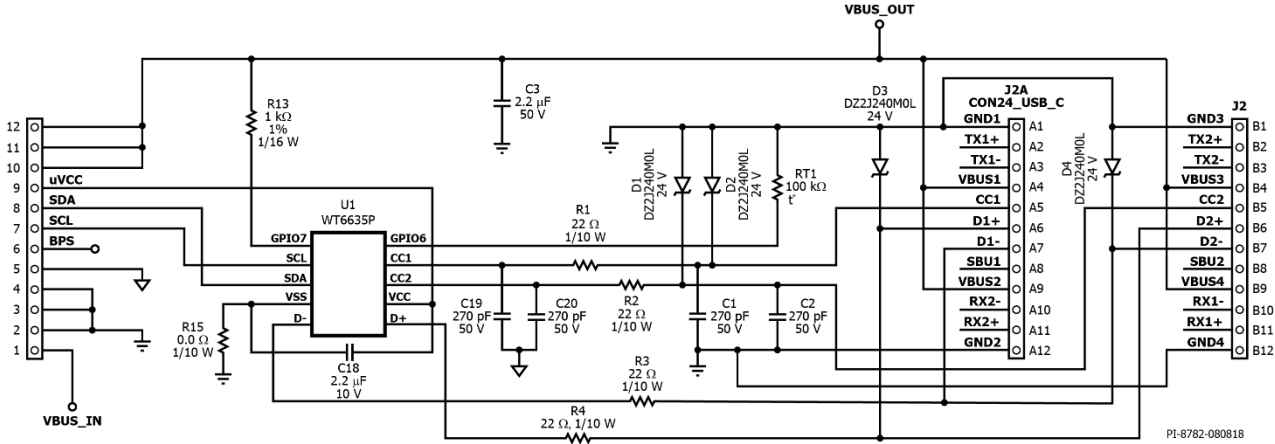

Figure 7 – Schematic of Daughter Board.



4 Circuit Description

4.1 *Mother Board Circuit Description*

4.1.1 Input Rectifier and Filter

Fuse F1 isolates the circuit and provides protection from component failure, and the common mode choke L2 with capacitor C1 and C3 provides attenuation for EMI. Bridge rectifier BR1 rectifies the AC line voltage and provides a full wave rectified DC across C2. Thermistor RT1 limits the inrush current when the power supply is connected to the input AC supply.

4.1.2 InnoSwitch3-Pro IC Primary

One end of the transformer primary is connected to the rectified DC bus; the other is connected to the drain terminal of the MOSFET inside the InnoSwitch3-Pro IC (U1). Resistors R1 and R2 provide input voltage sense protection for undervoltage and overvoltage conditions.

A low cost RCD clamp formed by diode D1, resistors R3, R4 and R22, and capacitor C4 limits the peak Drain voltage of U1 at the instant of turn off of the MOSFET inside U1. The clamp helps to dissipate the energy stored in the leakage reactance of transformer T1.

The IC is self-starting, using an internal high-voltage current source to charge the BPP pin capacitor (C6) when AC is first applied. During normal operation the primary side block is powered from an auxiliary winding on the transformer T1. Output of the auxiliary (or bias) winding is rectified using diode D2 and filtered using capacitor C7. Resistor R7 limits the current being supplied to the BPP pin of the InnoSwitch3-Pro IC (U1). A linear regulator comprising resistor R8, R23, BJT Q1 and Zener diode VR1 ensures sufficient current flows through R7 such that the internal current source is not required to charge C6 during normal operation. The RC network comprising of resistor R5 and capacitor C5 offers damping to the high frequency ringing in the voltage across diode D2 which reduces radiated EMI.

Zener diodes VR2 and VR3 offer primary sensed output overvoltage protection. In a flyback converter, output of the auxiliary winding tracks the output voltage of the converter. In case of over voltage at output of the converter, the auxiliary winding voltage increases and causes breakdown of VR2 which then causes a current to flow into the BPP pin of InnoSwitch3-Pro IC U1. If the current flowing into the BPP pin increases above the I_{SD} threshold, the InnoSwitch3-Pro controller will latch off and prevent any further increase in output voltage. Resistor R6 limits the current injected to BPP pin.

4.1.3 InnoSwitch3-Pro IC Secondary

The secondary-side of the InnoSwitch3-Pro IC provides output voltage, output current sensing and drive to a MOSFET providing synchronous rectification. The secondary of the transformer is rectified by MOSFET Q2 and filtered by capacitors C12 and C13. High frequency ringing during switching transients that would otherwise create radiated EMI is reduced via a RC snubber, R9 and C8.

The gate of Q2 is turned on by secondary-side controller inside IC U1, based on the secondary winding voltage sensed via resistor R10 and fed into the FWD pin of the IC.

In continuous conduction mode of operation, the MOSFET is turned off just prior to the secondary-side commanding a new switching cycle from the primary. In discontinuous mode of operation, the power MOSFET is turned off when the voltage drop across the MOSFET falls below a threshold of approximately $V_{SR(TH)}$. Secondary-side control of the primary-side power MOSFET avoids any possibility of cross conduction of the two MOSFETs and provides extremely reliable synchronous rectifier operation.

The secondary-side of the IC is self-powered from either the secondary winding forward voltage or the output voltage. Capacitor C9 connected to the BPS pin of InnoSwitch3-Pro IC U1 provides decoupling for the internal circuitry.

During CC operation, when the output voltage falls, the device will power itself from the secondary winding directly. During the on-time of the primary-side power MOSFET, the forward voltage that appears across the secondary winding is used to charge the SECONDARY BYPASS pin decoupling capacitor C9 via resistor R10 and an internal regulator. This allows output current regulation to be maintained down to 3.0 V. Below this level the unit enters auto-restart until the output load is reduced. Capacitor C10 is needed between the VOUT pin and the SECONDARY GROUND pin for ESD protection of the VOUT pin.

Output current is sensed by monitoring the voltage drop across resistor R11 between the IS and SECONDARY GROUND pins. A threshold of approximately 32 mV reduces losses. A decoupling capacitor C14 is needed between the IS and SECONDARY GROUND pin to improve CC accuracy. Resistors R12 and R20 provide a positive slope to the CC characteristic. Once the internal current sense threshold is exceeded, the device regulates the number of switch pulses to maintain a fixed output current. When the output current is below the CC threshold, the device operates in constant voltage mode. The output voltage is set by the I²C interface.

N-MOSFET Q3 forms the bus switch and is controlled by the VB/D pin on the InnoSwitch3-Pro IC. When the bus switch is opened, resistor R13 and diode D3 are needed from the source of the MOSFET to its gate for providing a voltage discharge path for capacitor C3 on the daughter board.



4.2 ***Daughter Board Circuit Description***

4.2.1 USB Type-C and PD Interface

In this design, WT6635P (U1) is the USB Type-C and PD controller. Output of the InnoSwitch3-Pro IC powers the WT6635P device through the uVCC pin. USB PD protocol is communicated over either CC1 or CC2 line depending on the orientation in which Type-C plug is connected.

WT6635P IC communicates with InnoSwitch3-Pro IC through the I²C interface using the SCL and SDA pins through which it sets the CV, CC, V_{KP}, OVA and UVA parameters. The status of the InnoSwitch3-Pro IC is read by the WT6635P IC from the telemetry registers also using the I²C interface.

Capacitor C18 provides decoupling to the WT6635P IC. Capacitors C19, C20, C1, C2; resistors R1, R2, R3 and R4; TVS D1, D2, D3 and D4 provide protection from ESD to pins CC1, CC2, D1 and D2. Thermistor (RT1) connected to pin GPIO6 of the WT6635P IC provides temperature detection functionality of the Type-C connector.

5 PCB Layout

PCB copper thickness is 0.062 inches.

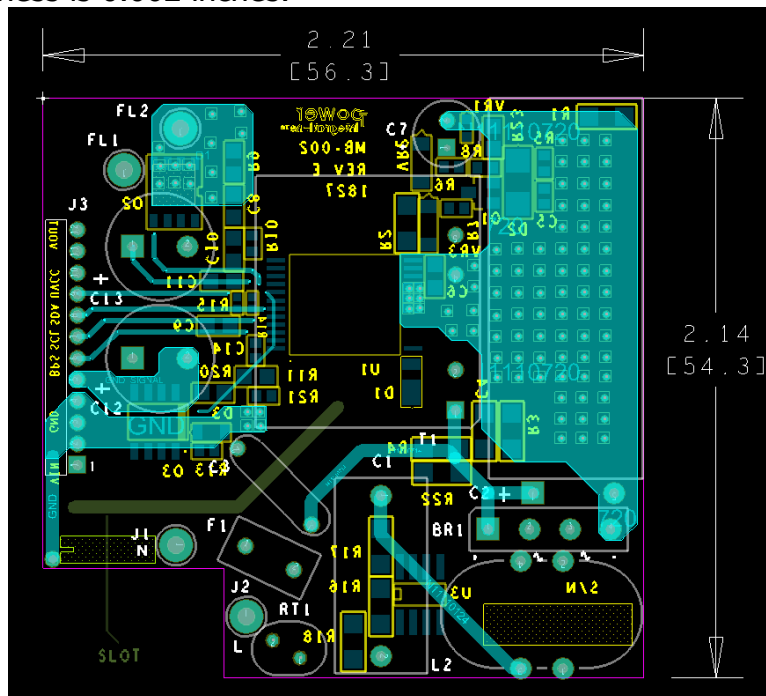

Figure 8 – Printed Circuit Layout, Mother Board, Top.

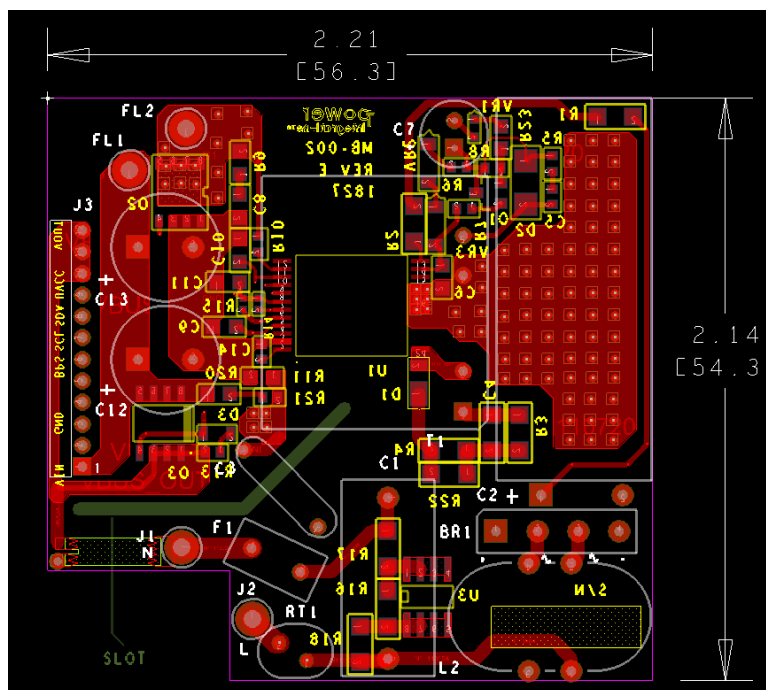

Figure 9 – Printed Circuit Layout, Mother Board, Bottom.

Note: Component references U3, R14, R15, R17 and R18 although present in the layout; they are not to be populated.

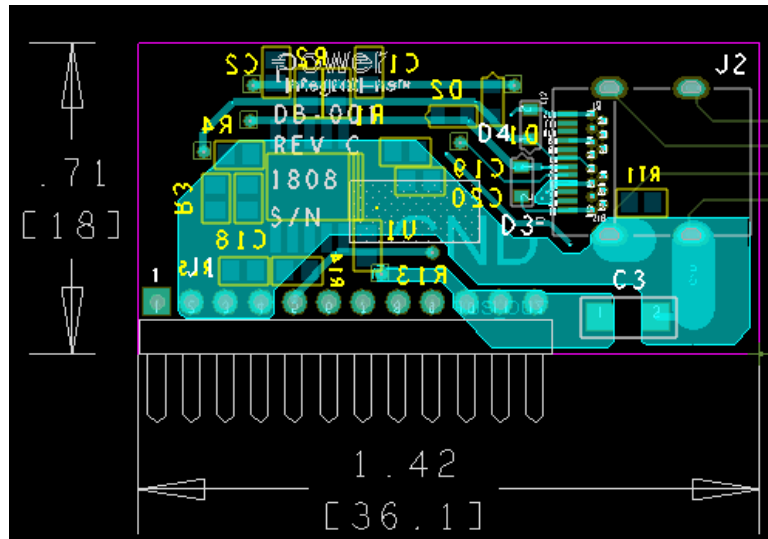

Figure 10 – Printed Circuit Layout, Daughter Board, Top.

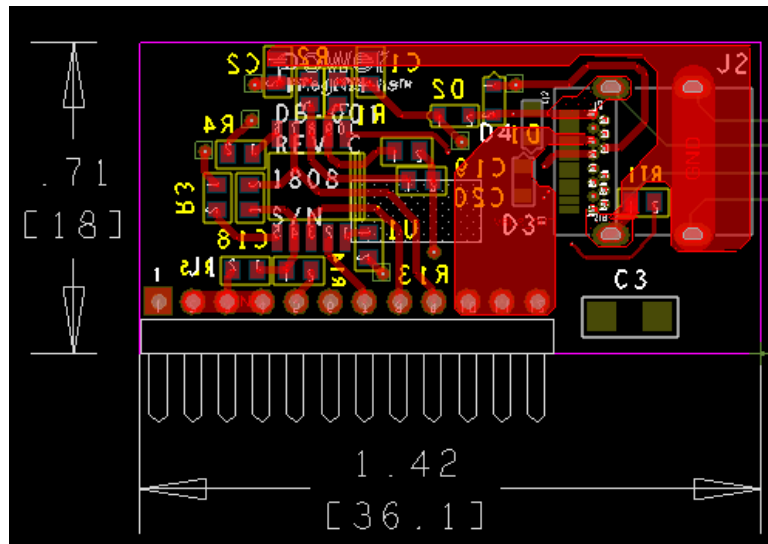
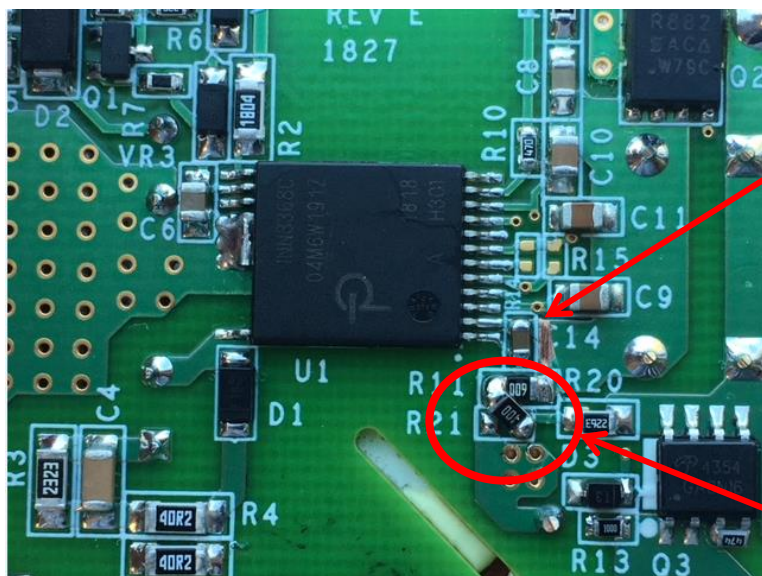

Figure 11 – Printed Circuit Layout, Daughter Board, Bottom.

Note: Component reference R14 although present in the layout, is not be populated.

5.1 **PCB Modifications**



Notch created on PCB. This is done in order to ensure Kelvin connection to R_{SENSE} from GND pin.

R21: 10 Ω; One end of the resistor is placed on top of R11. This is done in order to ensure Kelvin connection to R_{SENSE} from IS pin.

Figure 12 – Modifications done on Printed Circuit Board, Bottom.

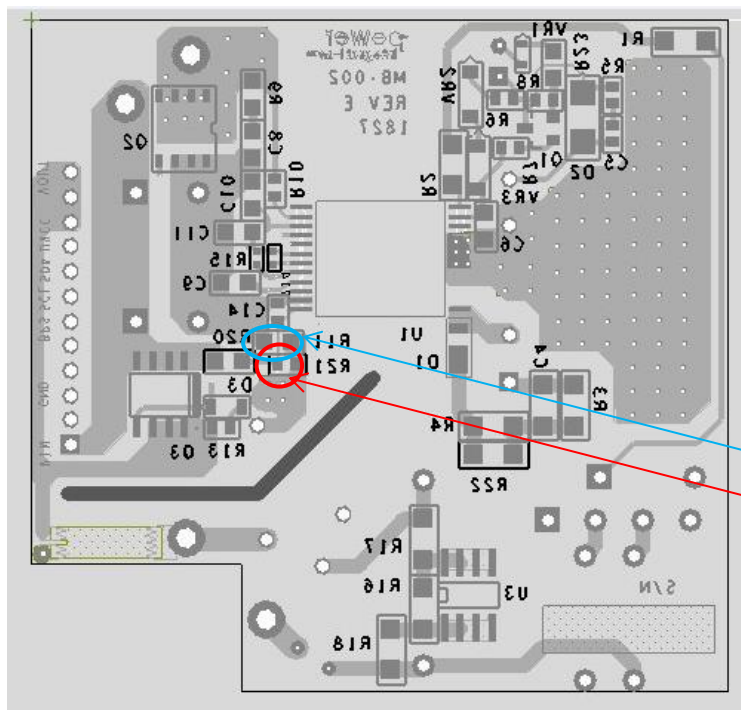

R11; 9 mΩ

R21: 10 Ω; Left edge of resistor is desoldered from pad and soldered on top of R11

Figure 13 – Modification 1; Repositioning of R21 on Printed Circuit Board image, Bottom.

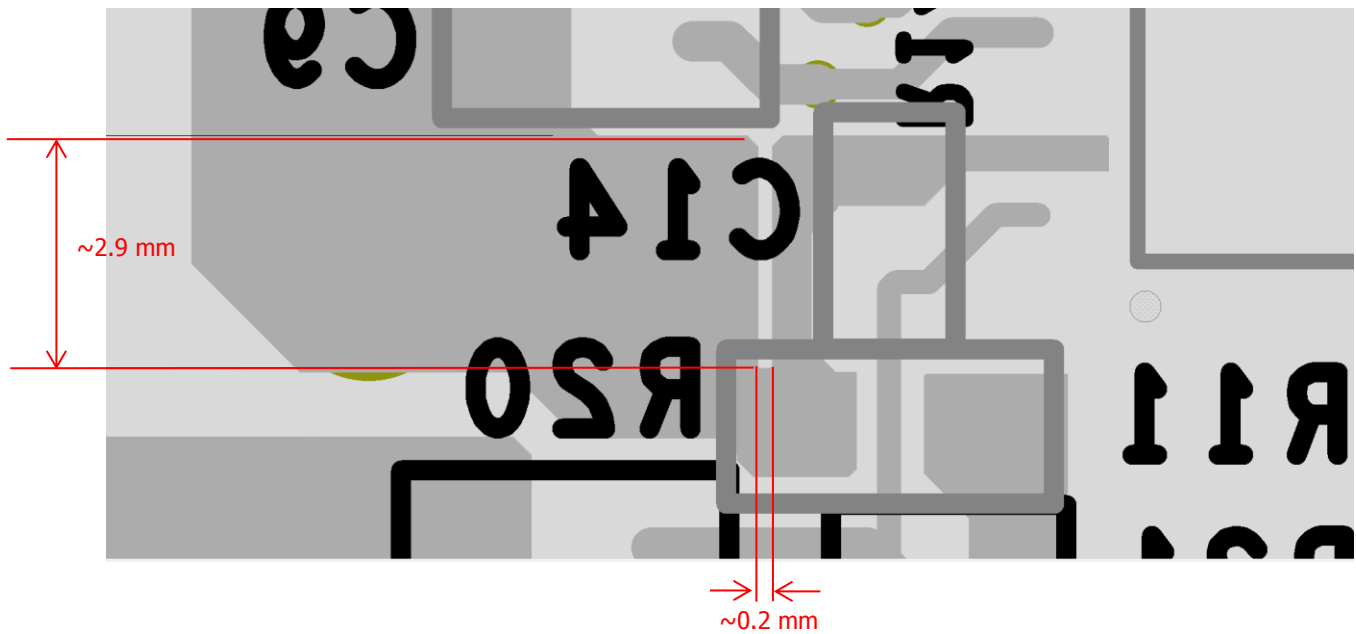

Figure 14 – Modification 2; Etching Away of Copper on Printed Circuit Board Image, Bottom. Kelvin Sensing from GND Pin to Sense Resistor R11.

6 Bill of Materials – Mother Board

Item	Qty	Ref Des	Description	Mfg Part Number	Mfg
1	1	BR1	600 V, 3 A, Bridge Rectifier, GBP	KBP306G-BP	Micro Commercial
2	1	C1	100 nF, 275VAC, Film, X2	F1772-410-2000	Vishay
3	1	C2	82 μ F, 400 V, Electrolytic, Low ESR, (14.5 x 35)	EPAG401ELL820MU35S	Nippon Chemi-Con
4	1	C3	1 nF, Ceramic, Y1	440LD10-R	Vishay
5	1	C4	2.2 nF, 630 V, Ceramic, X7R, 1206	C3216X7R2J222K	TDK
6	1	C5	56 pF, 250 V, Ceramic, NPO, 0603	GQM1875C2E560JB12D	Murata
7	1	C6	4.7 μ F, 50 V, Ceramic, X5R, 0805	CL21A475KBQNNNE	Samsung
8	1	C7	22 μ F, 63, Electrolytic, Low ESR, 1000 m Ω , (6.3 x 11.5)	ELXZ630ELL220MFB5D	Nippon Chemi-Con
9	1	C8	1 nF, 200 V, Ceramic, X7R, 0805	08052C102KAT2A	AVX
10	3	C9, C10, C11	2.2 μ F, 25 V, Ceramic, X7R, 0805	C2012X7R1E225M	TDK
11	2	C12 C13	470 μ F, 25 V, \pm 20%, Al Organic Polymer, Gen. Purpose, Can, 15 m Ω , 2000 Hrs @ 105°C	A750MS477M1EAAE015	KEMET
12	1	C14	4.7 μ F, 10 V, Ceramic, X5R, 0603	C1608X5R1A475M/0.50	TDK
13	1	D1	800 V, 1 A, Rectifier, POWERDI123	DFLR1800-7	Diodes, Inc.
14	1	D2	600 V, 1 A, Fast Recovery, 250 ns, SMA	RS1J-13-F	Diodes, Inc.
15	1	D3	250 V, 0.2 A, Fast Switching, 50 ns, SOD-323	BAV21WS-7-F	Diodes, Inc.
16	1	F1	2 A, 250 V, Slow, Long Time Lag, RST	RST 2	Belfuse
17	2	J1 J2	Test point, THRU-HOLE Mount	5010	Keystone
19	1	L2	34 mH, Toroidal Common Mode Choke, custom	32-00345-00	Power Integrations
19	1	Q1	NPN, 100V, 20 Ma, SOT23-3	DSC2C01S0L	Panasonic
20	1	Q2	100 V, 60 A, 8.7 m Ω , N-Channel, PowerPAK SO-8	SIR882ADP-T1-GE3	Vishay
21	1	Q3	MOSFET, N-CH, 30 V, 23 A (Ta), 3.1W (Ta), 3.7 m Ω (@ 20 A, 10 V), 8SOIC	AO4354	Alpha & Omega Semi
22	1	R1	RES, 1.91 M Ω , 1%, 1/4 W, Thick Film, 1206	RMCF1206FT1M91	Stackpole
23	1	R2	RES, 1.80 M Ω , 1%, 1/4 W, Thick Film, 1206	ERJ-8ENF1804V	Panasonic
24	1	R3	RES, 232 k Ω , 1%, 1/4 W, Thick Film, 1206	ERJ-8ENF2323V	Panasonic
25	2	R4 R22	RES, 40.2 Ω , 1%, 1/4 W, Thick Film, 1206	ERJ-8ENF40R2V	Panasonic
26	2	R5 R6	RES, 22 Ω , 5%, 1/10 W, Thick Film, 0603	ERJ-3GEYJ220V	Panasonic
27	1	R7	RES, 6.49 k Ω , 1%, 1/16 W, Thick Film, 0603	ERJ-3EKF6491V	Panasonic
28	1	R8	RES, 267 k Ω , 1%, 1/16 W, Thick Film, 0603	ERJ-3EKF2673V	Panasonic
29	1	R9	RES, 10 Ω , 1%, 1/8 W, Thick Film, 0805	ERJ-6ENF10R0V	Panasonic
30	1	R10	RES, 47 Ω , 5%, 1/10 W, Thick Film, 0603	ERJ-3GEYJ470V	Panasonic
31	1	R11	RES, 0.009 Ω , 0.5 W, 1%, 0805	CRF0805-FZ-R009ELF	Bourns
32	1	R13	RES, 100 Ω , 1%, 1/16 W, Thick Film, 0603	ERJ-3EKF1000V	Panasonic
33	1	R20	RES, 226 k Ω , 1%, 1/8 W, Thick Film, 0805	ERJ-6ENF2263V	Panasonic
34	1	R21	RES, 10 Ω , 1%, 1/16 W, Thick Film, 0603	ERJ-3EKF10R0V	Panasonic
35	1	R23	RES, 30.1 k Ω , 1%, 1/8 W, Thick Film, 0805	ERJ-6ENF3012V	Panasonic
36	1	R24	RES, 470 k Ω , 5%, 1/10 W, Thick Film, 0603	ERJ-3GEYJ474V	Panasonic
37	1	RT1	NTC Thermistor, 5 Ω , 1 A	MF72-005D5	Cantherm
38	1	T1	Bobbin, RM8, Vertical, 12 pins	P-803	Pin Shine
39	1	U1	InnoSwitch3-Pro, InSOP24D package	INN3368C-H301	Power Integrations
40	1	VR1	33 V, 5%, 200 mW, SSMINI-2	DZ2S33000L	Panasonic
41	1	VR2	DIODE ZENER 30 V 500 mW SOD123	MMSZ5256B-7-F	Diodes, Inc.
42	1	VR3	DIODE ZENER 20 V 500 mW SOD123	MMSZ5250B-7-F	Diodes, Inc.



7 Bill of Materials – Daughter Board

Item	Qty	Ref Des	Description	Mfg Part Number	Mfg
1	4	C1 C2 C19 C20	CAP, CER, 270 pF, ±5%, 50 V, Low ESL, COG/NP0, 0603 (1608 Metric)	C0603C2711J5GACTU	Kemet
2	1	C3	2.2 µF, 50 V, Ceramic, Y5V, 1206	UMK316F225ZG-T	Taiyo Yuden
3	1	C18	2.2 µF, 10 V, Ceramic, X5R, 0603	GRM188R61A225KE34D	Murata
4	4	D1 D2 D3 D4	DIODE, ZENER, 24 V, 200 mW, SMINI2	DZ2J240M0L	Panasonic
5	1	J1	15 Position (1 x 15) header, 2 mm pitch, Right Angle	NRPN151PARN-RC	Sullins Connector
6	1	J2	Connector, "Certified", USB - C, USB 3.1, For 0.062" PCB Material!, Superspeed+, Receptacle Connector, 24 Position, Surface Mount, Right Angle, Through Hole	632723300011	Wurth
7	4	R1 R2 R3 R4	RES, 22 Ω, 5%, 1/10 W, Thick Film, 0603	ERJ-3GEYJ220V	Panasonic
8	1	R13	RES, 1 kΩ, 1%, 1/16 W, Thick Film, 0603	ERJ-3EKF1001V	Panasonic
9	1	R15	RES, 0 Ω, 5%, 1/10 W, Thick Film, 0603	ERJ-3GEY0R00V	Panasonic
10	1	RT1	NTC Thermistor, 100 kΩ, 3%, 0603	NCP18WF104E03RB	Murata
11	1	U1	USB PD Controller	WT6635P	Weltrend

8 Transformer Specification

8.1 Electrical Diagram

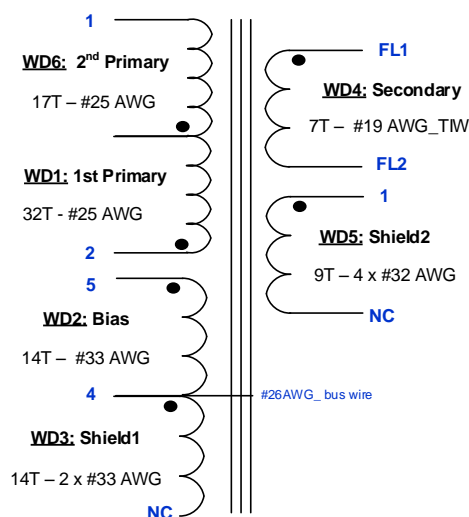

Figure 15 – Transformer Electrical Diagram.

8.2 Electrical Specifications

Electrical Strength	1 second, 60 Hz, from ins 1-5 to leads: FL1-FL2.	3000 VAC
Primary Inductance	Pins 1-2, all other open, measured at 100 kHz, 0.4 V _{RMS} .	502 μH, ±5%
Resonant Frequency	Pins 1-2, all other open.	1200 kHz (Min.)
Primary Leakage	Pins 1-2, with leads FL1-FL2 shorted, measured at 100 KHz, 0.4 V _{RMS} .	9.0 μH (Max.)

8.3 Material List

Item	Description
[1]	Core: RM8, TDK-PC45; or Equivalent. Gapped ALG: 213nH/T ² .
[2]	Bobbin: RM8, Vertical, 12 pins (6/6), in-line, PI#: 25-00041-00; or Equivalent.
[3]	Magnet Wire: #25 AWG, Double Coated.
[4]	Magnet Wire: #33 AWG, Double Coated.
[5]	Magnet Wire: #32 AWG, Double Coated.
[6]	Magnet Wire: #19 AWG, Triple Insulated Wire.
[7]	Tape: 3M 1298 Polyester Film, 1 mil Thick, 9.0 mm Wide.
[8]	Bus Wire: #26 AWG, Alpha Wire, Tinned Copper; or Equivalent.
[9]	Clip: Epcos, Clamp RM8, MF#: B65812A2203X; or Equivalent.
[10]	Tape: 3M 1298 Polyester Film, 1 mil Thick, 27.5 mm x 58.0 mm.
[11]	Varnish: Dolph BC-359; or Equivalent.

8.4 Transformer Build Diagram

WD6: 2nd Primary	17T – #25 AWG
WD5: Shield2	9T – 4 x #32 AWG
WD4: Secondary	5T – # 21AWG_TW
WD3: Shield 1 <small>(wound interleave with...)</small>	14T – 2 x #33 AWG
WD2: Bias	14T – #33 AWG
WD1: 1st Primary	32T - #25 AWG

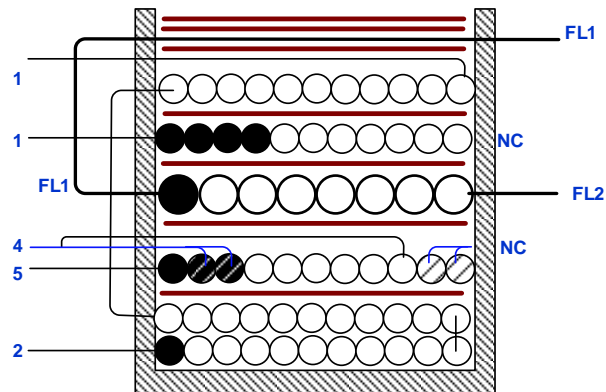
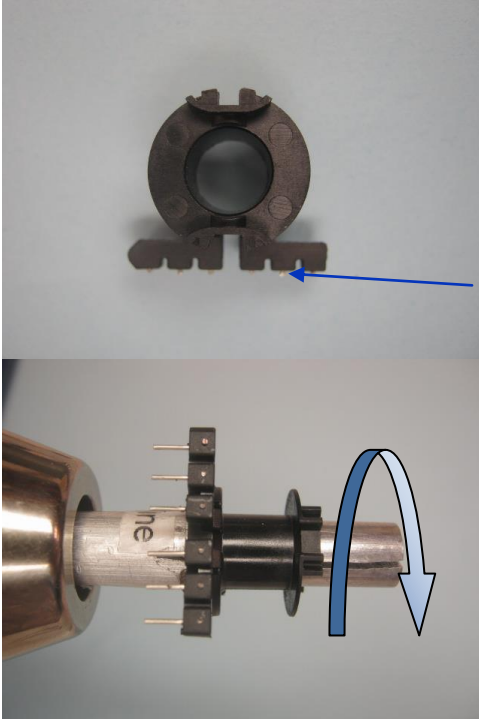
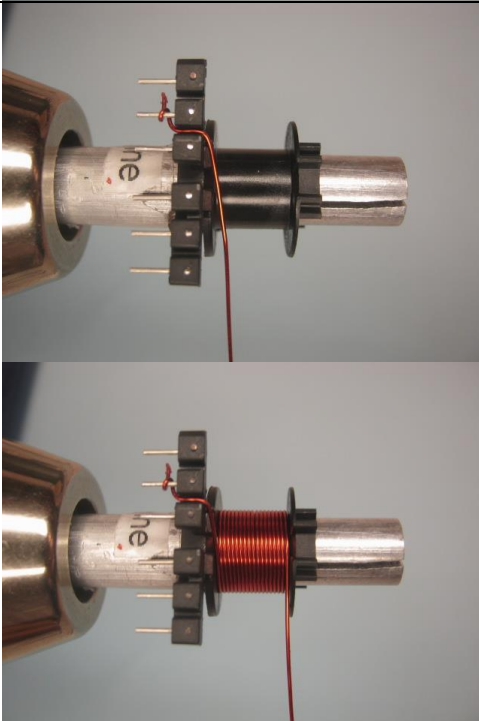

Figure 16 – Transformer Build Diagram.

8.5 Transformer Construction

Winding Preparation	Trim off the secondary bottom flange and cut short all side pins of bobbin Item [2]. (see picture below) Position the bobbin Item [2] on the mandrel such that the primary side of the bobbin is on the left side. Winding direction is clock-wise direction for purpose of these instructions.
WD1 1st Primary	Start at pin 2, wind 32 turns of wire Item [3] in 2 layers, with tight tension, from left to right then right to left. At the last turn, exit the wire; leave floating enough length for WD6-2 nd primary.
Insulation	1 layer of tape Item [7].
WD2 Bias & WD3 Shield 1	Start at pin 5 with single wire Item [4] for Bias winding, and pin 4 with 2 wires also Item [4] for Shield1 winding. Wind all 3 wires in parallel 14 turns from left to right. At the last turn, bring the single wire back to the left and terminate at pin 4 for Bias winding, and cut short 2 wires no-connect for Shield 1 winding.
Insulation	1 layer of tape Item [7].
WD4 Secondary	Start from left slot of secondary side of bobbin, use single wire Item [6], leaves floating ~2", mark as FL1 and wind 5 turns from left right with tight tension. At the last turn exit the wires at right slot of secondary bobbin and leave floating ~2" and mark as FL2.
Insulation	1 layer of tape Item [7].
WD5 Shield 2	Start at pin 1, wind 9 quad-filar turns of wire Item [5], from left to right evenly. At the last turn, cut short wires as no-connect.
Insulation	1 layer of tape Item [7].
WD6 2nd Primary	Now take the wire floating from WD1, continue winding 17 turns from left to right. At the last turn bring the wire back to the left and finish at pin 1.
Insulation	1 layer of tape Item [8], bring wires floating FL1 to the right and add 2 layers of tape for secure windings.
Finish	Gap cores to get 513 μ H, secure with clips Item [9] (pins of clips should be on top and cut short), and solder bus wire Item [8] to pin 4 and to top of clip. Varnish with Item [11]. Place 2 layers of tape Item [9] at bottom core and wrap up to the body of transformer. 1 layer of tap Item [8] wrap around the transformer. (See pictures below).

8.6 **Winding Illustrations**

<p>Winding Preparation</p>		<p>Trim off the secondary bottom flange and cut short all side pins of bobbin Item [2]. Position the bobbin Item [2] on the mandrel such that the primary side of the bobbin is on the left side. Winding direction is clockwise direction for purpose of these instructions.</p>
<p>WD1 1st Primary</p>		<p>Start at pin 2, wind 32 turns of wire Item [3] in 2 layers, with tight tension, from left to right then right to left. At the last turn, exit the wire; leave floating enough length for WD6-2nd primary.</p>

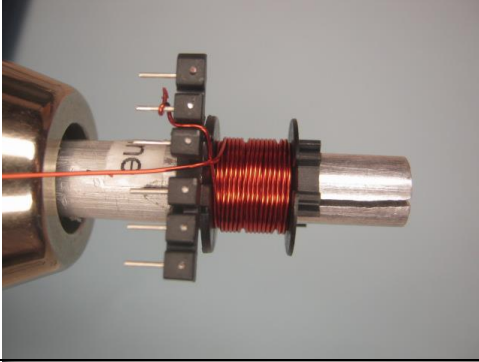
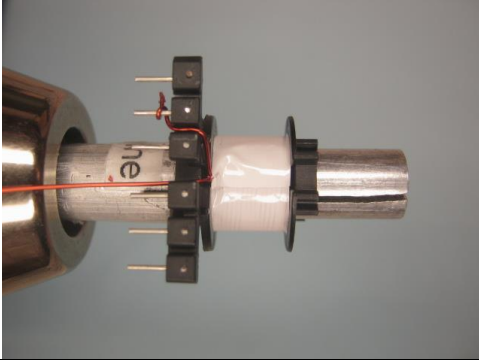
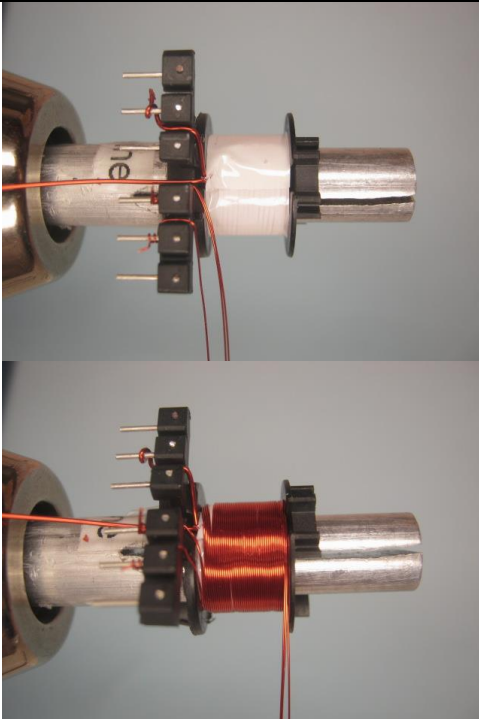
		
<p>Insulation</p>		<p>1 layer of tape Item [7].</p>
<p>WD2 Bias & WD3 Shield 1</p>		<p>Start at pin 5 with single wire Item [4] for Bias winding, and pin 4 with 2 wires also Item [4] for Shield1 winding. Wind all 3 wires in parallel 14 turns from left to right. At the last turn, bring the single wire back to the left and terminate at pin 4 for Bias winding, and cut short 2 wires no-connect for Shield 1 winding.</p>

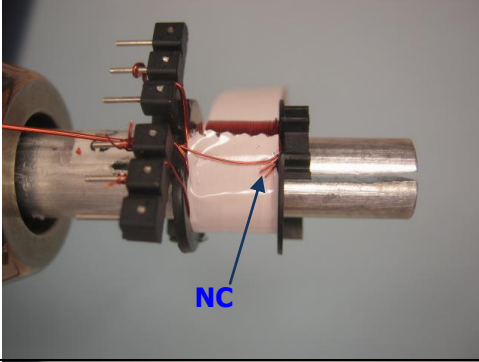
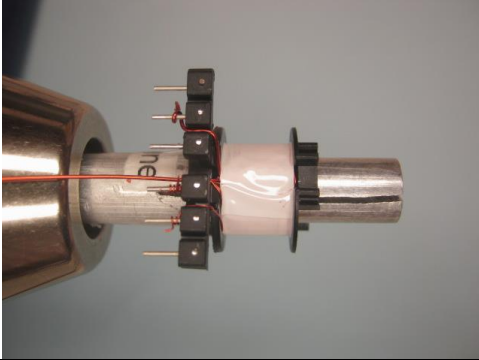
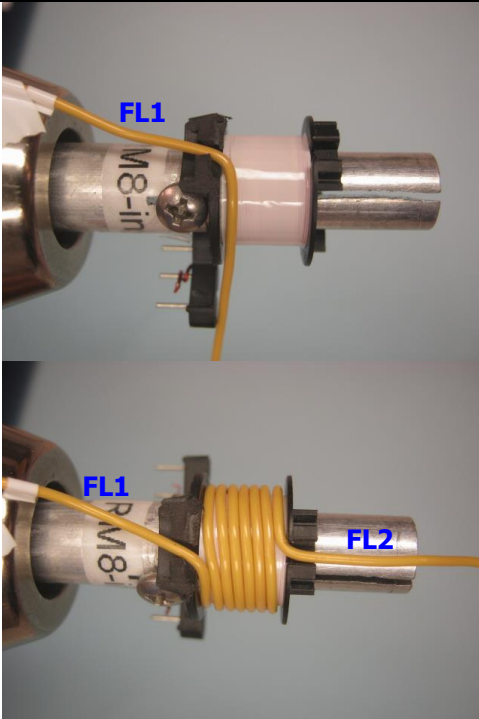
		
<p>Insulation</p>		<p>1 layer of tape Item [7].</p>
<p>WD4 Secondary</p>		<p>Start from left slot of secondary side of bobbin, use single wire Item [6], leaves floating ~2", mark as FL1 and wind 5 turns from left right with tight tension. At the last turn exit the wires at right slot of secondary bobbin and leave floating ~2" and mark as FL2.</p>

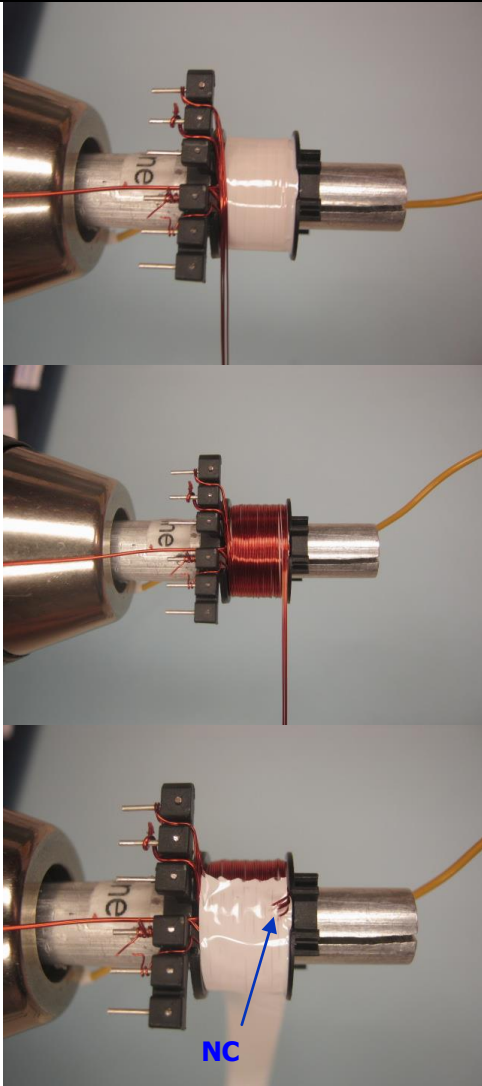
<p>Insulation</p>		<p>1 layer of tape Item [7].</p>
<p>WD5 Shield 2</p>		<p>Start at pin 1, wind 9 quad-filar turns of wire Item [5], from left to right evenly. At the last turn, cut short wires as no-connect.</p>

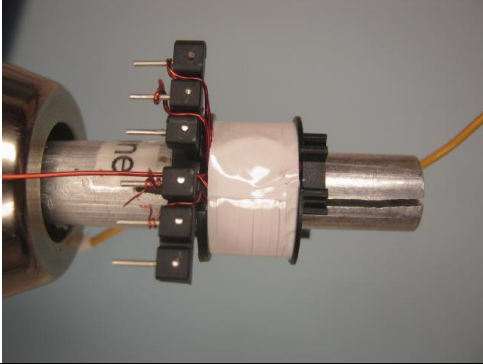
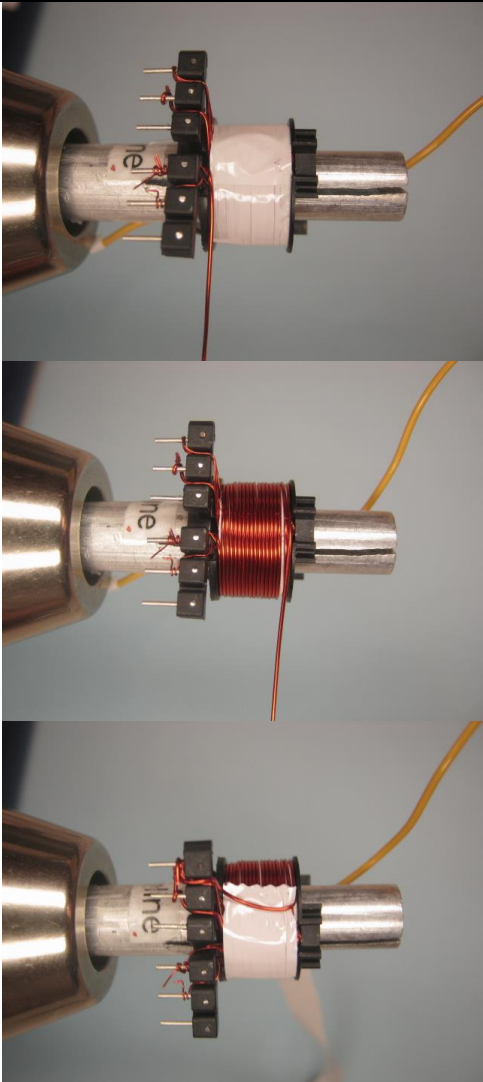
<p>Insulation</p>		<p>1 layer of tape Item [7].</p>
<p>WD6 2nd Primary</p>		<p>Now take the wire floating from WD1, continue winding 17 turns from left to right. At the last turn bring the wire back to the left and finish at pin 1.</p>

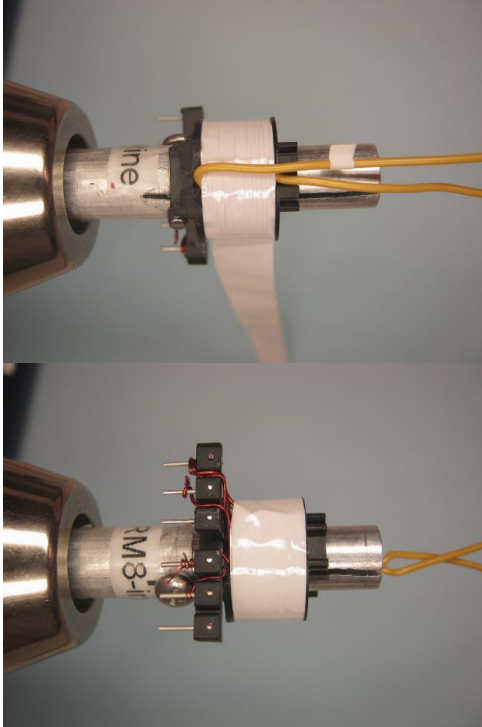
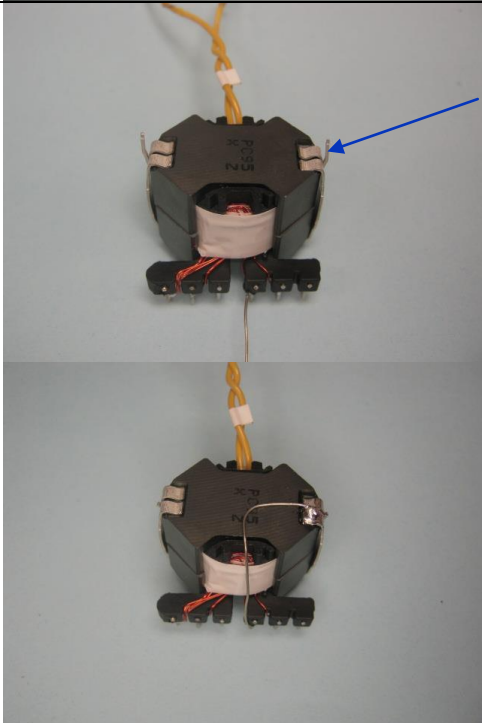
<p>Insulation</p>		<p>1 layer of tape Item [8], bring wires floating FL1 to the right and add 2 layers of tape for secure windings.</p>
<p>Finish</p>		<p>Gap cores to get 513 μH, secure with clips Item [9] (pins of clips should be on top and cut short), and solder bus wire Item [8] to pin 4 and to top of clip. Varnish with Item [11]. Place 2 layers of tape Item [9] at bottom core and wrap up to the body of transformer. 1 layer of tap Item [8] wrap around the transformer.</p>



9 Common Mode Choke Specifications

9.1 34 mH Common Mode Choke (L1)

9.1.1 Electrical Diagram

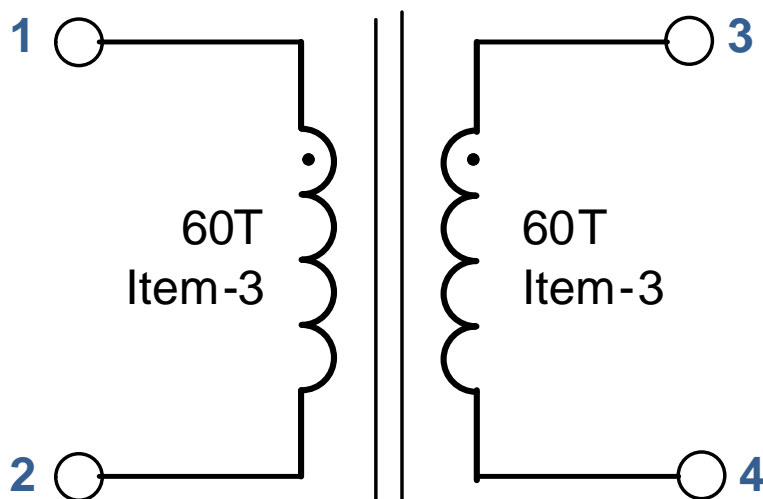

Figure 17 – Inductor Electrical Diagram.

9.1.2 Electrical Specifications

Winding Inductance	Pin 1 – pin 2 (pin 3 – pin 4), all other windings open, measured at 100 kHz, 0.4 V _{RMS} .	34 mH, ±20%
Winding Leakage Inductance	Short pin 2 and pin 4, then measure between pin 1 and pin 3.	>80 μH

9.1.3 Material List

Item	Description
[1]	Toroidal Core: Encom T16-10-7C, PI#: 32-00343-00.
[2]	Margin Tape: Polyester Web, 3M 44 or Equivalent, 3.2 mm Wide; or Equivalent.
[3]	Magnet Wire: #27 AWG, Double Coated.
[4]	Varnish: Dolph BC-359.

9.1.4 Illustrations



Figure 18 – L1 Front View.

9.1.5 Winding Instructions

Item	Description
[1]	Put margin tape Item [2] into the toroid Item [1] to make 2 equal sections.
[2]	Use ~4 ½ ft of Item [3], start as pin 1 for the 1st section, wind 24 turns for 1st layer, then wind 12 turns for each layer: 2nd, 3rd, and 4th , and end as pin 2. (see illustration below).
[3]	Do the same for another 2nd section of Toroid but wind symmetrically, start as pin 3 and end at pin 4.
[4]	Varnish Item [4].
[5]	Note: All wires should be left ~1.5" floating. Make sure to label each terminal.

10 Transformer Design Spreadsheet

1	ACDC_InnoSwitch3-Pro_Flyback_042018; Rev.1.0; Copyright Power Integrations 2018	INPUT	INFO	OUTPUT	UNITS	InnoSwitch3-Pro Flyback Design Spreadsheet
2	APPLICATION VARIABLES					
3	VAC_MIN			85	V	Minimum AC line voltage
4	VAC_MAX			265	V	Maximum AC input voltage
5	VAC_RANGE			UNIVERSAL		AC line voltage range
6	FLINE			60	Hz	AC line voltage frequency
7	CAP_INPUT	82.0		82.0	uF	Input capacitance
9	SETPOINT 1					
10	VOUT1	20.00		20.00	V	Output voltage 1, should be the highest output voltage required
11	IOUT1	2.250		2.250	A	Output current 1
12	POUT1			45.00	W	Output power 1
13	EFFICIENCY1	0.89		0.89		Converter efficiency for output 1
14	Z_FACTOR1	0.50		0.50		Z-factor for output 1
16	SETPOINT 2					
17	VOUT2	15.00		15.00	V	Output voltage 2
18	IOUT2	3.000		3.000	A	Output current 2
19	POUT2			45.00	W	Output power 2
20	EFFICIENCY2	0.90		0.90		Converter efficiency for output 2
21	Z_FACTOR2	0.50		0.50		Z-factor for output 2
23	SETPOINT 3					
24	VOUT3	9.00		9.00	V	Output voltage 3
25	IOUT3	3.000		3.000	A	Output current 3
26	POUT3			27.00	W	Output power 3
27	EFFICIENCY3	0.89		0.89		Converter efficiency for output 3
28	Z_FACTOR3	0.50		0.50		Z-factor for output 3
30	SETPOINT 4					
31	VOUT4	5.00		5.00	V	Output voltage 4
32	IOUT4	3.000		3.000	A	Output current 4
33	POUT4			15.00	W	Output power 4
34	EFFICIENCY4	0.86		0.86		Converter efficiency for output 4
35	Z_FACTOR4	0.50		0.50		Z-factor for output 4
37	SETPOINT 5					
38	VOUT5	3.00		3.00	V	Output voltage 5
39	IOUT5	3.000		3.000	A	Output current 5
40	POUT5			9.00	W	Output power 5
41	EFFICIENCY5	0.84		0.84		Converter efficiency for output 5
42	Z_FACTOR5	0.50		0.50		Z-factor for output 5
44	SETPOINT 6					
45	VOUT6			0.00	V	Output voltage 6
46	IOUT6			0.000	A	Output current 6
47	POUT6			0.00	W	Output power 6
48	EFFICIENCY6			0.00		Converter efficiency for output 6
49	Z_FACTOR6			0.00		Z-factor for output 6
51	SETPOINT 7					
52	VOUT7			0.00	V	Output voltage 7
53	IOUT7			0.000	A	Output current 7
54	POUT7			0.00	W	Output power 7
55	EFFICIENCY7			0.00		Converter efficiency for output 7
56	Z_FACTOR7			0.00		Z-factor for output 7
58	SETPOINT 8					
59	VOUT8			0.00	V	Output voltage 8
60	IOUT8			0.000	A	Output current 8
61	POUT8			0.00	W	Output power 8
62	EFFICIENCY8			0.00		Converter efficiency for output 8
63	Z_FACTOR8			0.00		Z-factor for output 8

65	SETPOINT 9					
66	VOUT9			0.00	V	Output voltage 9
67	IOUT9			0.000	A	Output current 9
68	POUT9			0.00	W	Output power 9
69	EFFICIENCY9			0.00		Converter efficiency for output 9
70	Z_FACTOR9			0.00		Z-factor for output 9
72	VOLTAGE_CDC	0.000		0.000	V	Cable drop compensation desired at full current
76	PRIMARY CONTROLLER SELECTION					
77	ENCLOSURE	ADAPTER		ADAPTER		Power supply enclosure
78	ILIMIT_MODE	INCREASED		INCREASED		Device current limit mode
79	VDRAIN_BREAKDOWN	650		650	V	Device breakdown voltage
80	DEVICE_GENERIC	Auto		INN33X8		Device selection
81	DEVICE_CODE			INN3368C		Device code
82	PDEVICE_MAX			50	W	Device maximum power capability
83	RDSON_25DEG			0.99	Ω	Primary MOSFET on-time resistance at 25°C
84	RDSON_100DEG			1.53	Ω	Primary MOSFET on-time resistance at 100°C
85	ILIMIT_MIN			1.683	A	Primary MOSFET minimum current limit
86	ILIMIT_TYP			1.850	A	Primary MOSFET typical current limit
87	ILIMIT_MAX			2.017	A	Primary MOSFET maximum current limit
88	VDRAIN_ON_MOSFET			0.89	V	Primary MOSFET on-time voltage drop
89	VDRAIN_OFF_MOSFET			583.31	V	Peak drain voltage on the primary MOSFET during turn-off
93	WORST CASE ELECTRICAL PARAMETERS					
94	FSWITCHING_MAX	79000	Info	79000	Hz	The worst case minimum operating frequency is less than 25kHz: may result in audible noise
95	VOR	140.0		140.0	V	Voltage reflected to the primary winding (corresponding to setpoint 1) when the primary MOSFET turns off
96	VMIN			82.75	V	Valley of the rectified minimum input AC voltage at full load
97	KP			0.734		Measure of continuous/discontinuous mode of operation
98	MODE_OPERATION			CCM		Mode of operation
99	DUTYCYCLE			0.631		Primary MOSFET duty cycle
100	TIME_ON			11.89	us	Primary MOSFET on-time
101	TIME_OFF			4.83	us	Primary MOSFET off-time
102	LPRIMARY_MIN			477.5	μ H	Minimum primary magnetizing inductance
103	LPRIMARY_TYP			502.7	μ H	Typical primary magnetizing inductance
104	LPRIMARY_TOL			5.0		Primary magnetizing inductance tolerance
105	LPRIMARY_MAX			527.8	μ H	Maximum primary magnetizing inductance
107	PRIMARY CURRENT					
108	Iavg_PRIMARY			0.584	A	Primary MOSFET average current
109	IPEAK_PRIMARY			1.873	A	Primary MOSFET peak current
110	IPEDestal_PRIMARY			0.433	A	Primary MOSFET current pedestal
111	IRIPPLE_PRIMARY			1.873	A	Primary MOSFET ripple current
112	IRMS_PRIMARY			0.854	A	Primary MOSFET RMS current
114	SECONDARY CURRENT					
115	IPEAK_SECONDARY			13.114	A	Secondary MOSFET peak current



116	IPEDESTAL_SECONDARY			3.029	A	Secondary MOSFET pedestal current
117	IRMS_SECONDARY			5.280	A	Secondary MOSFET RMS current
118	IRIPPLE_CAP_OUT			4.346	A	Output capacitor ripple current
122	TRANSFORMER CONSTRUCTION PARAMETERS					
123	CORE SELECTION					
124	CORE	RM8	Info	RM8		The transformer windings may not fit: pick a bigger core or bobbin and refer to the Transformer Parameters tab for fit calculations
125	CORE NAME			PC95RM08Z		Core code
126	AE			64.0	mm ²	Core cross sectional area
127	LE			38.0	mm	Core magnetic path length
128	AL			5290	nH	Ungapped core effective inductance per turns squared
129	VE			2430	mm ³	Core volume
130	BOBBIN NAME			B-RM08-V		Bobbin name
131	AW			30.0	mm ²	Bobbin window area
132	BW			8.80	mm	Bobbin width
133	MARGIN			0.0	mm	Bobbin safety margin
135	PRIMARY WINDING					
136	NPRIMARY			49		Primary winding number of turns
137	BPEAK			3475	Gauss	Peak flux density
138	BMAX			3112	Gauss	Maximum flux density
139	BAC			1552	Gauss	AC flux density (0.5 x Peak to Peak)
140	ALG			209	nH	Typical gapped core effective inductance per turns squared
141	LG			0.369	mm	Core gap length
142	LAYERS_PRIMARY			3		Primary winding number of layers
143	AWG_PRIMARY	25		25		Primary wire gauge
144	OD_PRIMARY_INSULATED			0.518	mm	Primary wire insulated outer diameter
145	OD_PRIMARY_BARE			0.455	mm	Primary wire bare outer diameter
146	CMA_PRIMARY			375.4	Cmils/A	Primary winding wire CMA
148	SECONDARY WINDING					
149	NSECONDARY			7		Secondary winding number of turns
150	AWG_SECONDARY			19		Secondary wire gauge
151	OD_SECONDARY_INSULATED			1.217	mm	Secondary wire insulated outer diameter
152	OD_SECONDARY_BARE			0.912	mm	Secondary wire bare outer diameter
153	CMA_SECONDARY			243.9	Cmils/A	Secondary winding wire CMA
155	BIAS WINDING					
156	NBIAS			22		Bias winding number of turns
160	PRIMARY COMPONENTS SELECTION					
161	LINE UNDERVOLTAGE					
162	BROWN-IN REQUIRED	75.00		75.00	V	Required line brown-in threshold
163	RLS			3.74	MΩ	Connect two 1.87 MOhm resistors to the V-pin for the required UV/OV threshold
164	BROWN-IN ACTUAL			74.98	V	Actual brown-in threshold using standard resistors
165	BROWN-OUT ACTUAL			67.82	V	Actual brown-out threshold using standard resistors
167	LINE OVERVOLTAGE					
168	OVERVOLTAGE_LINE		Warning	312.52	V	The device voltage stress will be higher than 90% of the breakdown voltage when overvoltage is triggered
170	BIAS WINDING					

171	VBIAS			9.00	V	Rectified bias voltage at the lowest output setpoint
172	VF_BIAS			0.70	V	Bias winding diode forward drop
173	VREVERSE_BIASDIODE			176.61	V	Bias diode reverse voltage (not accounting parasitic voltage ring)
174	CBIAS			22	uF	Bias winding rectification capacitor
175	CBPP			4.70	uF	BPP pin capacitor
179	SECONDARY COMPONENTS SELECTION					
180	RECTIFIER					
181	VDRAIN_OFF_SRFET			73.33	V	Secondary rectifier reverse voltage (not accounting parasitic voltage ring)
182	SRFET	Auto		SIR878ADP		Secondary rectifier (Logic MOSFET)
183	VBREAKDOWN_SRFET			100	V	Secondary rectifier breakdown voltage
184	RDSON_SRFET			18.0	mΩ	SRFET on time drain resistance at 25degC for VGS=4.4V
188	VARIABLE OUTPUTS ANALYSIS					
189	TOLERANCE CORNER					
190	CORNER_VAC			85	V	Input AC RMS voltage corner to be evaluated
191	CORNER_ILIMIT	TYP		1.850	A	Current limit corner to be evaluated
192	CORNER_LPRIMARY	TYP		502.7	uH	Primary inductance corner to be evaluated
194	SETPOINT SELECTION					
195	SETPOINT	5		5		Select the setpoint which needs to be evaluated
196	FSWITCHING			23795.3	Hz	Maximum switching frequency at full load and the valley of the minimum input AC voltage
197	VOR			21.6	V	Voltage reflected to the primary winding when the primary MOSFET turns off
198	VMIN			111.41	V	Valley of the minimum input AC voltage
199	KP			1.212		Measure of continuous/discontinuous mode of operation
200	MODE_OPERATION			DCM		Mode of operation
201	DUTYCYCLE			0.138		Primary MOSFET duty cycle
202	TIME_ON			5.80	us	Primary controller's maximum on-time
203	TIME_OFF			36.23	us	Primary controller's minimum off-time
205	PRIMARY CURRENT					
206	I AVG_PRIMARY			0.089	A	Primary MOSFET average current
207	I PEAK_PRIMARY			1.284	A	Primary MOSFET peak current
208	I PEDESTAL_PRIMARY			0.000	A	Primary MOSFET current pedestal
209	I RIPPLE_PRIMARY			1.284	A	Primary MOSFET ripple current
210	I RMS_PRIMARY			0.275	A	Primary MOSFET RMS current
212	SECONDARY CURRENT					
213	I PEAK_SECONDARY			8.987	A	Secondary MOSFET peak current
214	I PEDESTAL_SECONDARY			0.000	A	Secondary MOSFET pedestal current
215	I RMS_SECONDARY			4.376	A	Secondary MOSFET RMS current
216	I RIPPLE_CAP_OUT			3.185	A	Output capacitor ripple current
218	MAGNETIC FLUX DENSITY					
219	B PEAK			3035	Gauss	Peak flux density
220	B MAX			2058	Gauss	Maximum flux density
221	B AC			1029	Gauss	AC flux density (0.5 x Peak to Peak)



Notes:

1. (Fswitching) Info1: Audible Noise results when the device is operating at 20-20KHz region. However, the audible noise engine prevents the device from switching at these frequencies. Hence, this alert can be ignored.
2. (RM8 Core) Info2: We find that there is sufficient space on the core for all windings on the prototype. This warning can be ignored.
3. (Overvoltage Line) Warning: We find that there is sufficient margin above the datasheet specified breakdown voltage at normal operating voltage of 265 VAC. This warning is for abnormal operating conditions and can be ignored.



11 Performance Data

11.1 No-Load Input Power at 5 V Output

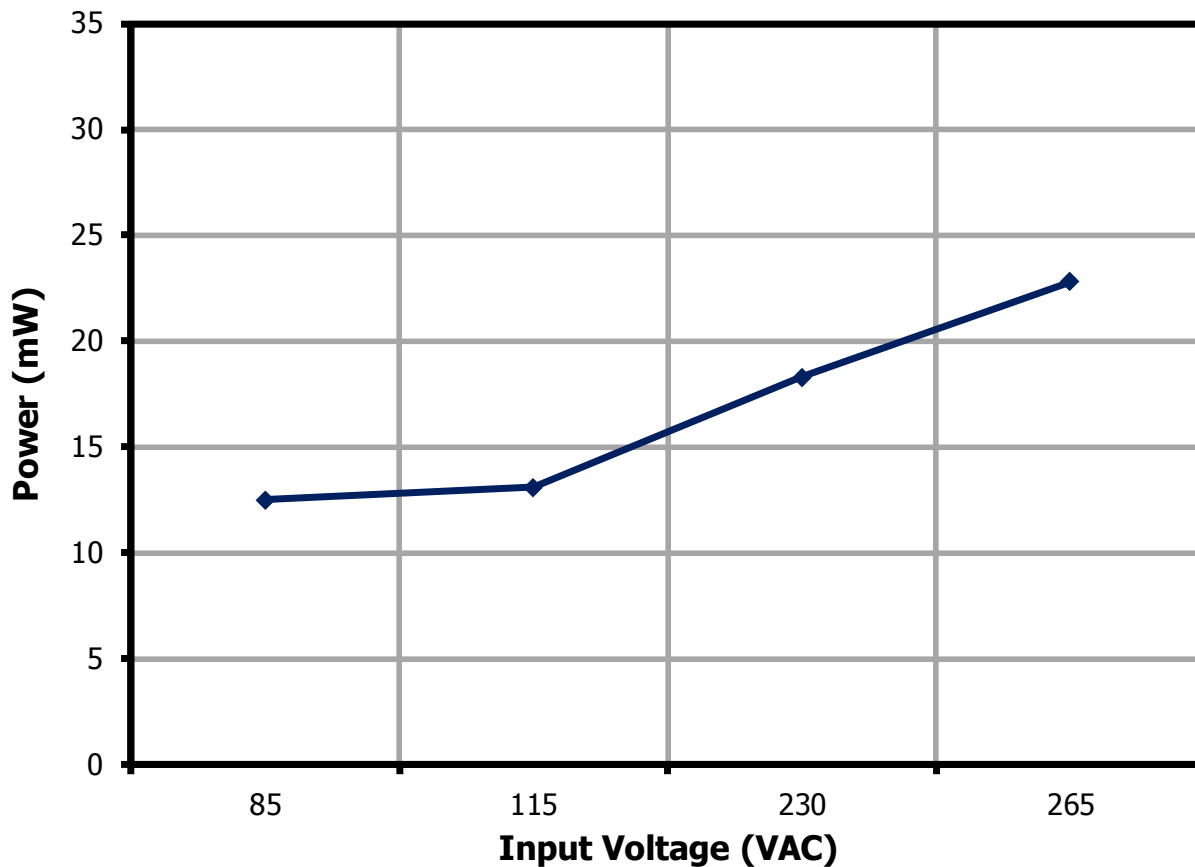

Figure 19 – No-Load Input Power vs. Input Line Voltage, Room Temperature.

11.1.1 Average Efficiency Requirements

Test	Power (W)	Average	Average	10% Load	Average	Average	10% Load
Model		<6 V Voltage	<6 V Voltage	<6 V Voltage	>6 V Voltage	>6 V Voltage	>6 V Voltage
Regulation		New IESA2007	CoC v5 Tier 2	CoC v5 Tier 2	New IESA2007	CoC v5 Tier 2	CoC v5 Tier 2
	9.9	78.6%	78.9%	69.7%			
	15	81.4 %	81.8%	72.5%			
	27				86.6%	87.3%	77.3%
	45				87.72%	88.85%	78.85%

11.1.2 Average Efficiency Summary

Power (W)	V _{OUT} (V)	Average		10% Load	
		115 VAC	230 VAC	115 VAC	230 VAC
9.9	3.3	87.34%	84.73%	83.14%	77.04%
15	5	89.46%	88.56%	88.43%	84.17%
27	9	90.15%	90.19%	86.54%	83.83%
45	15	89.99%	90.74%	86.37%	84.74%
	20	89.85%	90.48%	83.87%	82.26%

11.2 *Average Efficiency (On Board) and 10% Load at 115 VAC Input*

11.2.1 3.3 V Output

% Load	P_{OUT} (W)	Efficiency (%)	Average Efficiency (%) [100%-25%]
100	10.11	86.98	
75	7.64	87.61	
50	5.09	87.78	87.34
25	2.58	86.99	
10	0.94	83.14	

11.2.2 5.0 V Output

% Load	P_{OUT} (W)	Efficiency (%)	Average Efficiency (%) [100%-25%]
100	14.89	88.68	
75	11.06	89.37	
50	7.60	89.84	89.46
25	3.59	89.94	
10	1.29	88.43	

11.2.3 9.0 V Output

% Load	P_{OUT} (W)	Efficiency (%)	Average Efficiency (%) [100%-25%]
100	26.86	89.54	
75	20.31	90.08	
50	13.62	90.47	90.15
25	6.03	90.52	
10	1.74	86.54	

11.2.4 15.0 V Output

% Load	P_{OUT} (W)	Efficiency (%)	Average Efficiency (%) [100%-25%]
100	26.94	90.46	
75	20.34	90.64	
50	13.64	90.54	90.19
25	6.03	89.13	
10	1.75	83.83	

11.2.5 20.0 V Output

% Load	P _{OUT} (W)	Efficiency (%)	Average Efficiency (%)
100	44.58	90.19	
75	33.49	90.24	
50	22.39	90.09	89.85
25	11.15	88.87	
10	4.48	83.87	

11.3 **Average Efficiency (On Board) at 230 VAC Input and 10% Load**

11.3.1 3.3 V Output

% Load	P _{OUT} (W)	Efficiency (%)	Average Efficiency (%) [100%-25%]
100	10.14	85.89	
75	7.663	85.93	
50	5.09	84.88	84.73
25	2.58	82.22	
10	0.94	77.04	

11.3.2 5.0 V Output

% Load	P _{OUT} (W)	Efficiency (%)	Average Efficiency (%) [100%-25%]
100	14.96	88.84	
75	11.09	89.12	
50	7.62	88.89	88.56
25	3.59	87.38	
10	1.29	84.17	

11.3.3 9.0 V Output

% Load	P _{OUT} (W)	Efficiency (%)	Average Efficiency (%) [100%-25%]
100	26.94	90.46	
75	20.34	90.64	
50	13.64	90.54	90.19
25	6.03	89.13	
10	1.75	83.83	

11.3.4 15.0 V Output

% Load	P_{OUT} (W)	Efficiency (%)	Average Efficiency (%) [100%-25%]
100	44.91	91.15	
75	33.92	91.25	
50	22.68	90.96	90.74
25	11.36	89.62	
10	4.55	84.74	

11.3.5 20.0 V Output

% Load	P_{OUT} (W)	Efficiency (%)	Average Efficiency (%) [100%-25%]
100	44.64	91.42	
75	33.51	91.27	
50	22.41	90.76	90.47
25	11.14	88.44	
10	4.48	82.26	

11.4 Efficiency Across Load

11.4.1 5 V Output

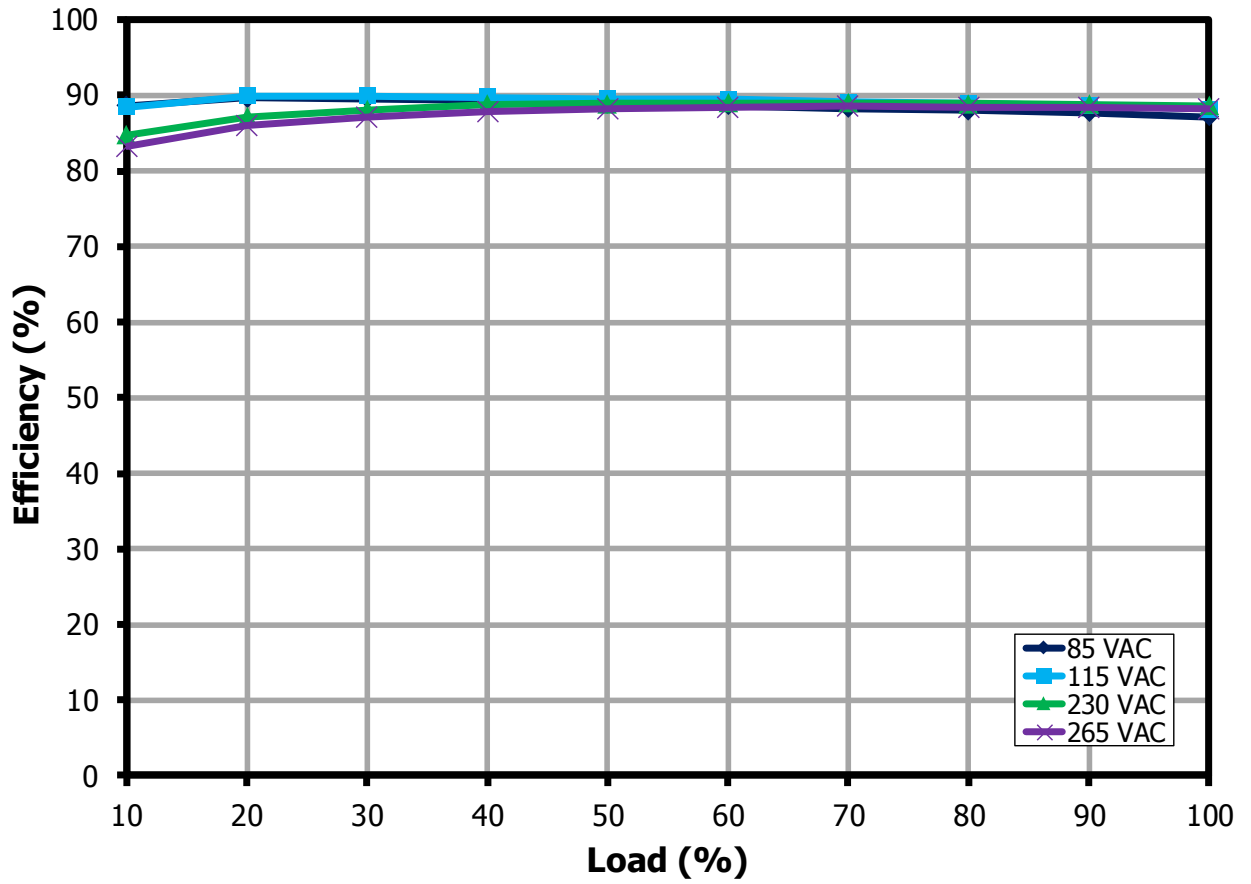

Figure 20 – 5 V Efficiency Across Load.



11.4.2 9 V Output

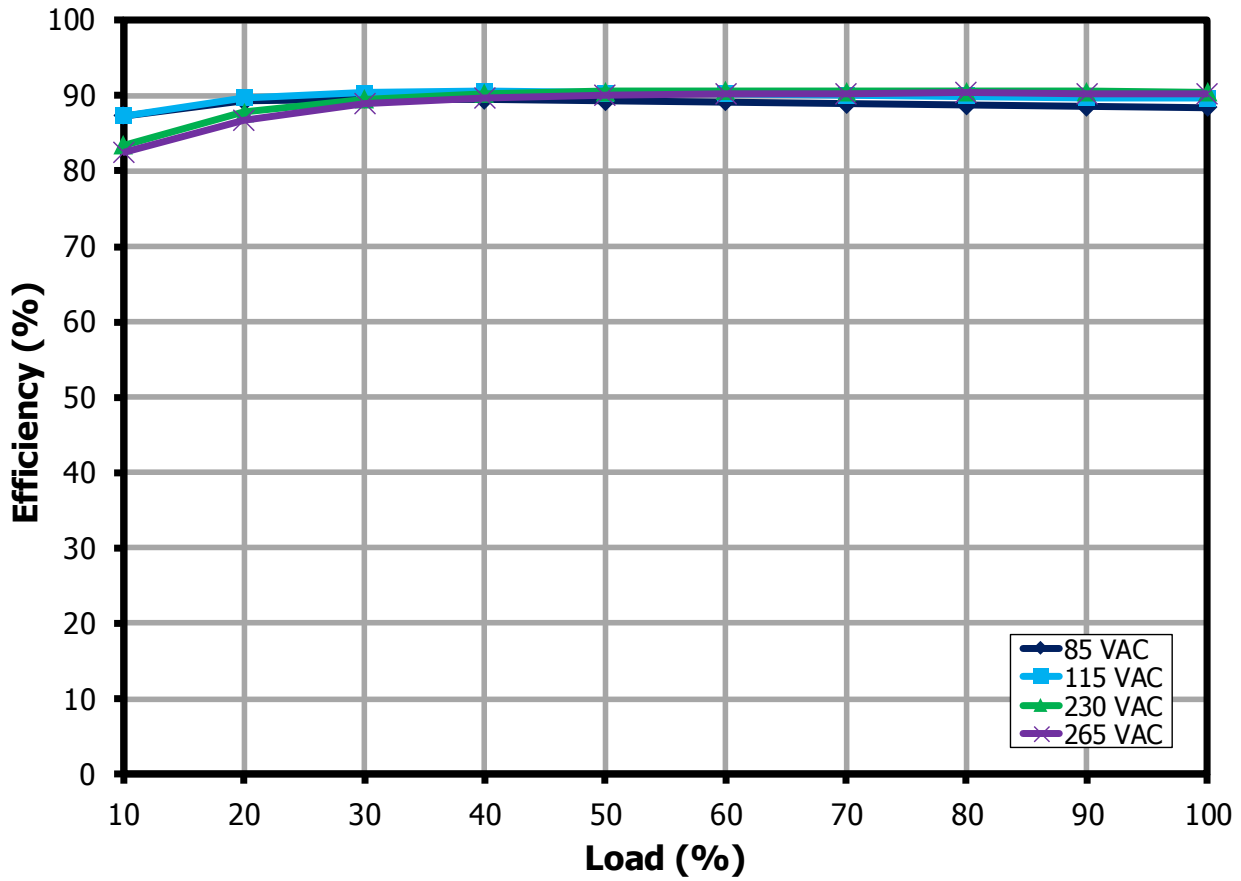

Figure 21 – 9 V Efficiency Across Load.

11.4.3 15 V Output

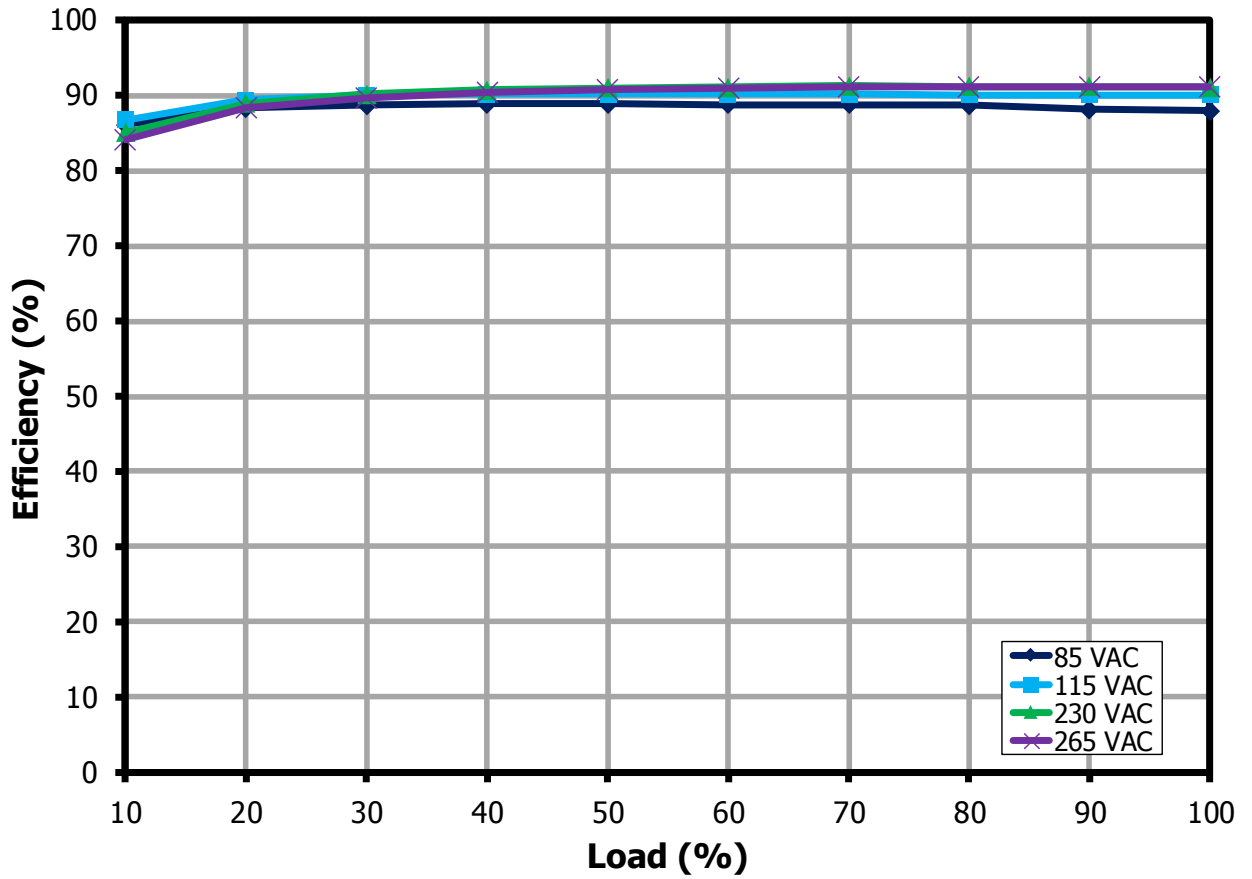

Figure 22 – 15 V Efficiency Across Load.



11.4.4 20 V Output

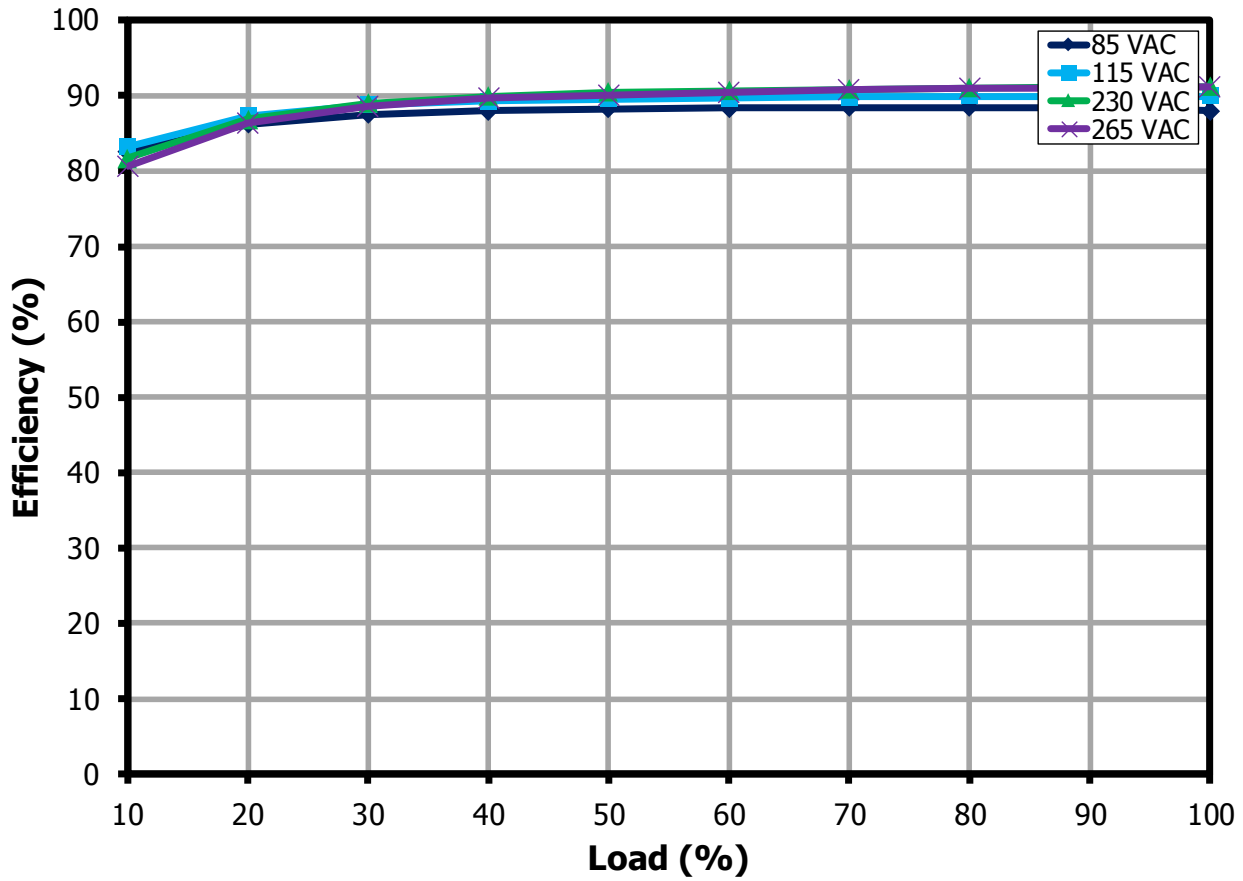

Figure 23 – 20 V Efficiency Across Load.

11.5 *Line Regulation (On Board)*

11.5.1 5.0 V Output

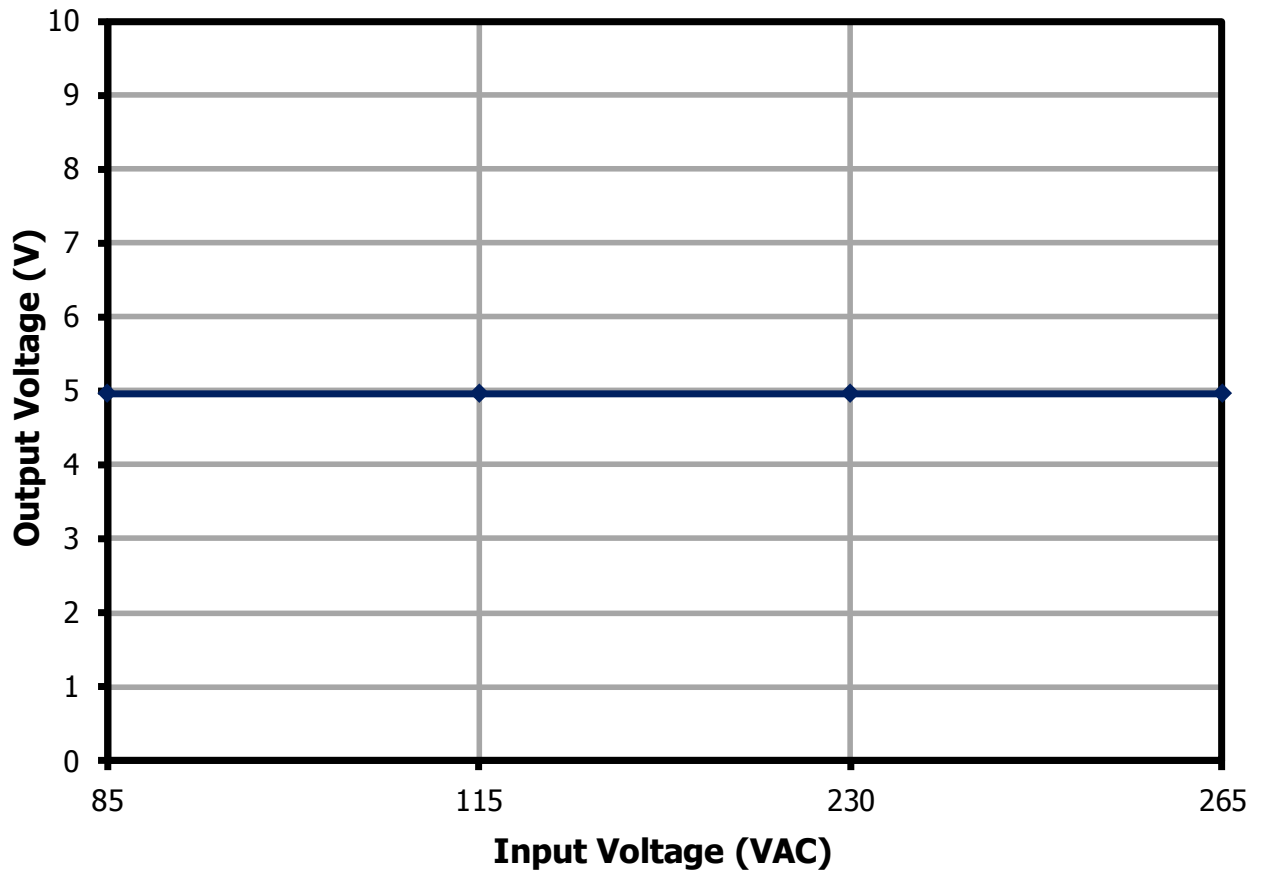

Figure 24 – Output Voltage vs. Input Line Voltage for 5 V Output, Room Temperature.



11.5.2 9.0 V Output

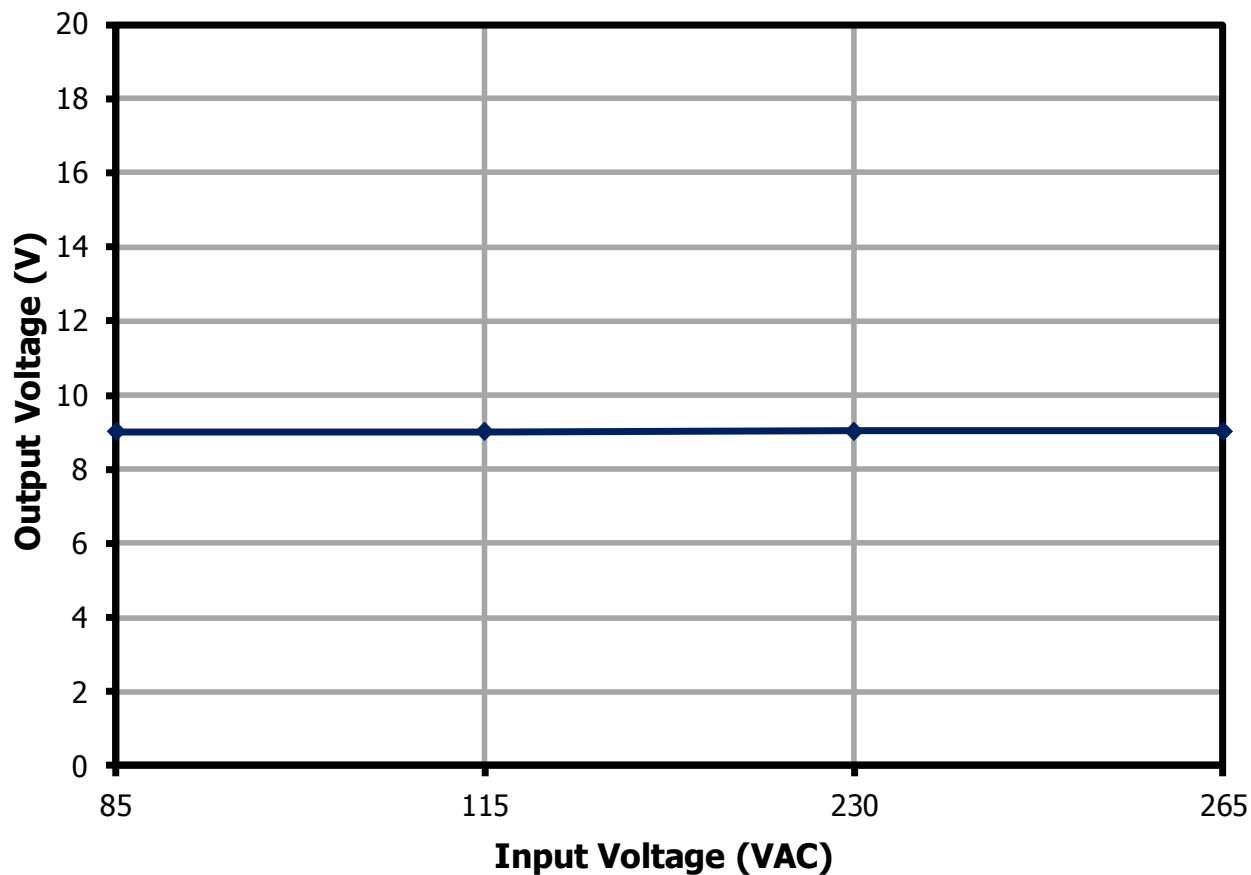

Figure 25 – Output Voltage vs. Input Line Voltage for 9 V Output, Room Temperature.

11.5.3 15.0 V Output

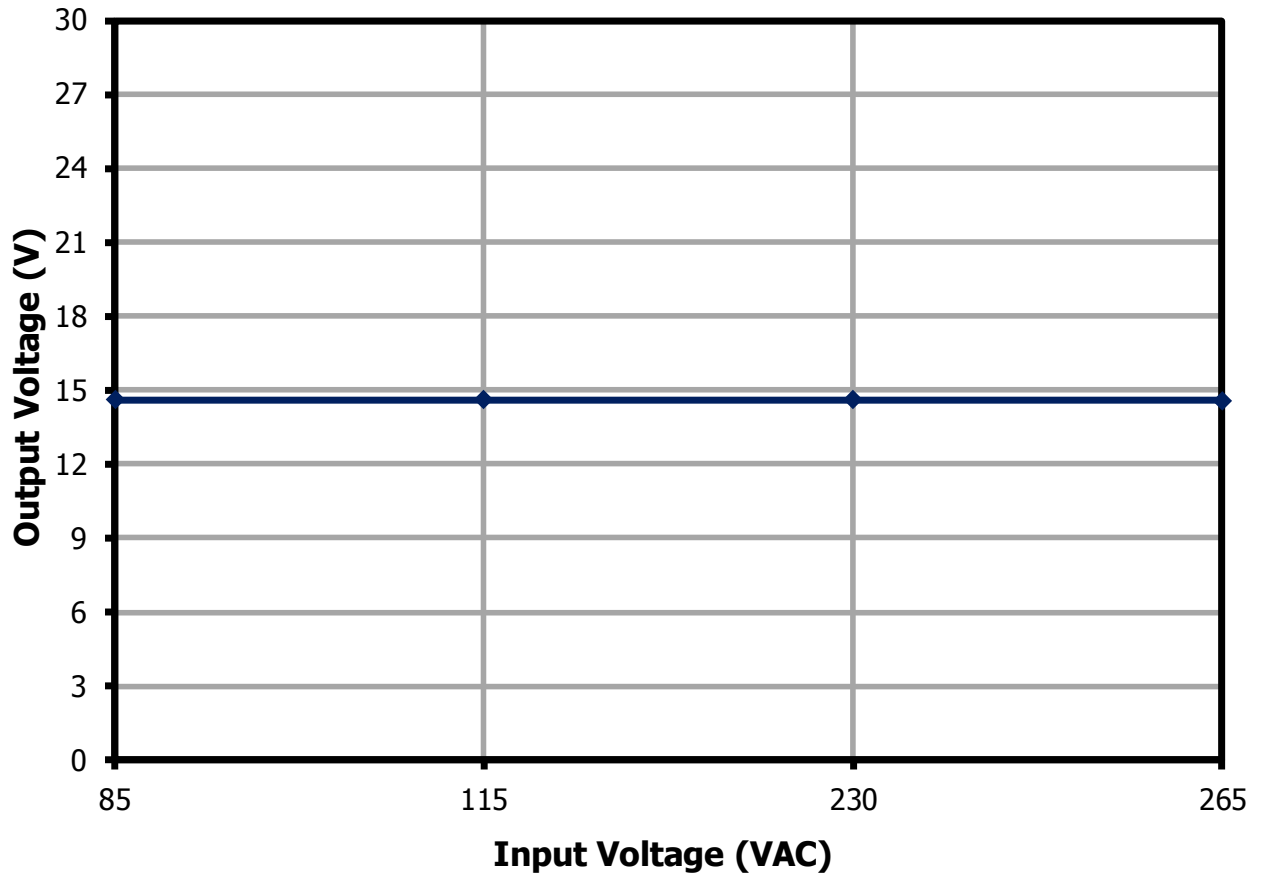

Figure 26 – Output Voltage vs. Input Line Voltage for 15 V Output, Room Temperature.



11.5.4 20.0 V Output

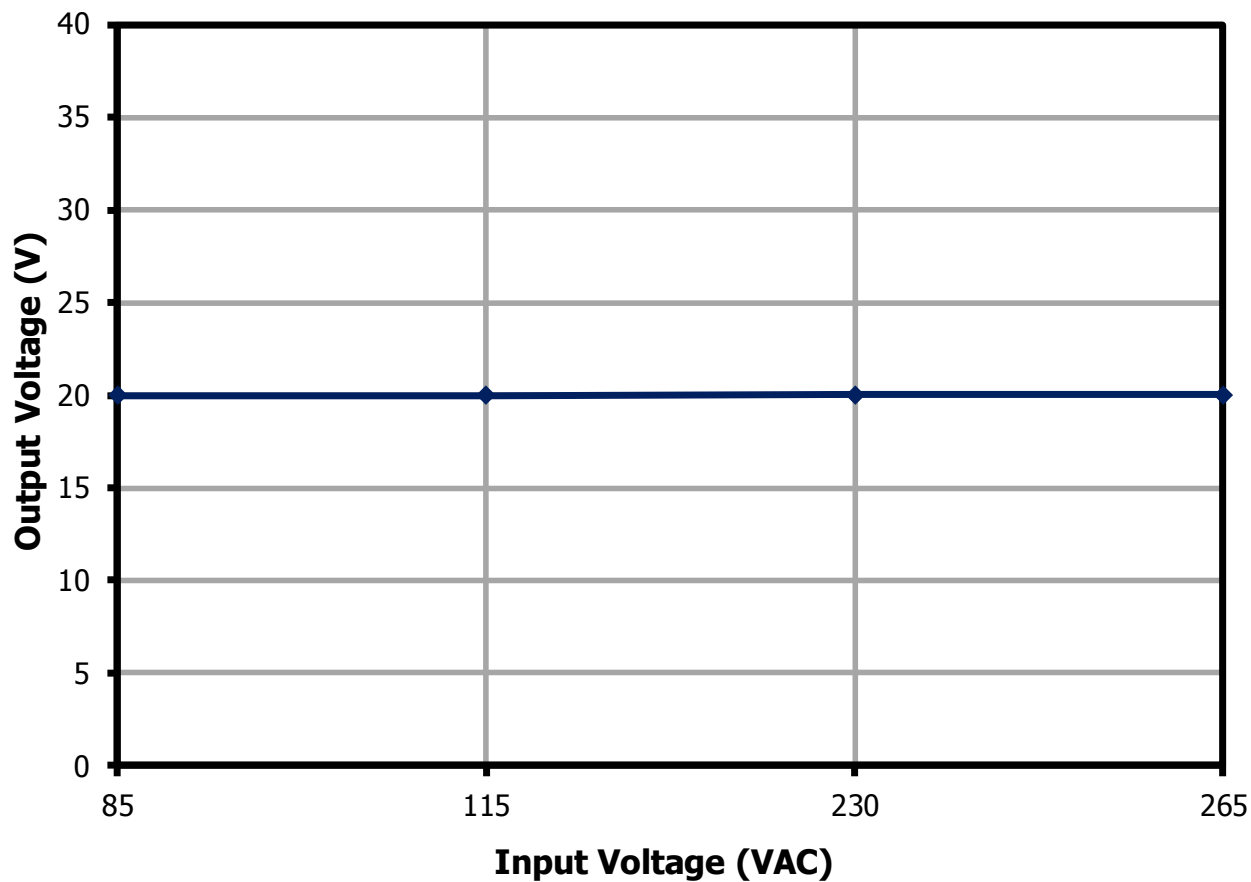

Figure 27 – Output Voltage vs. Input Line Voltage for 20 V Output, Room Temperature.

11.6 Load Regulation (On Board)

11.6.1 5.0 V Output

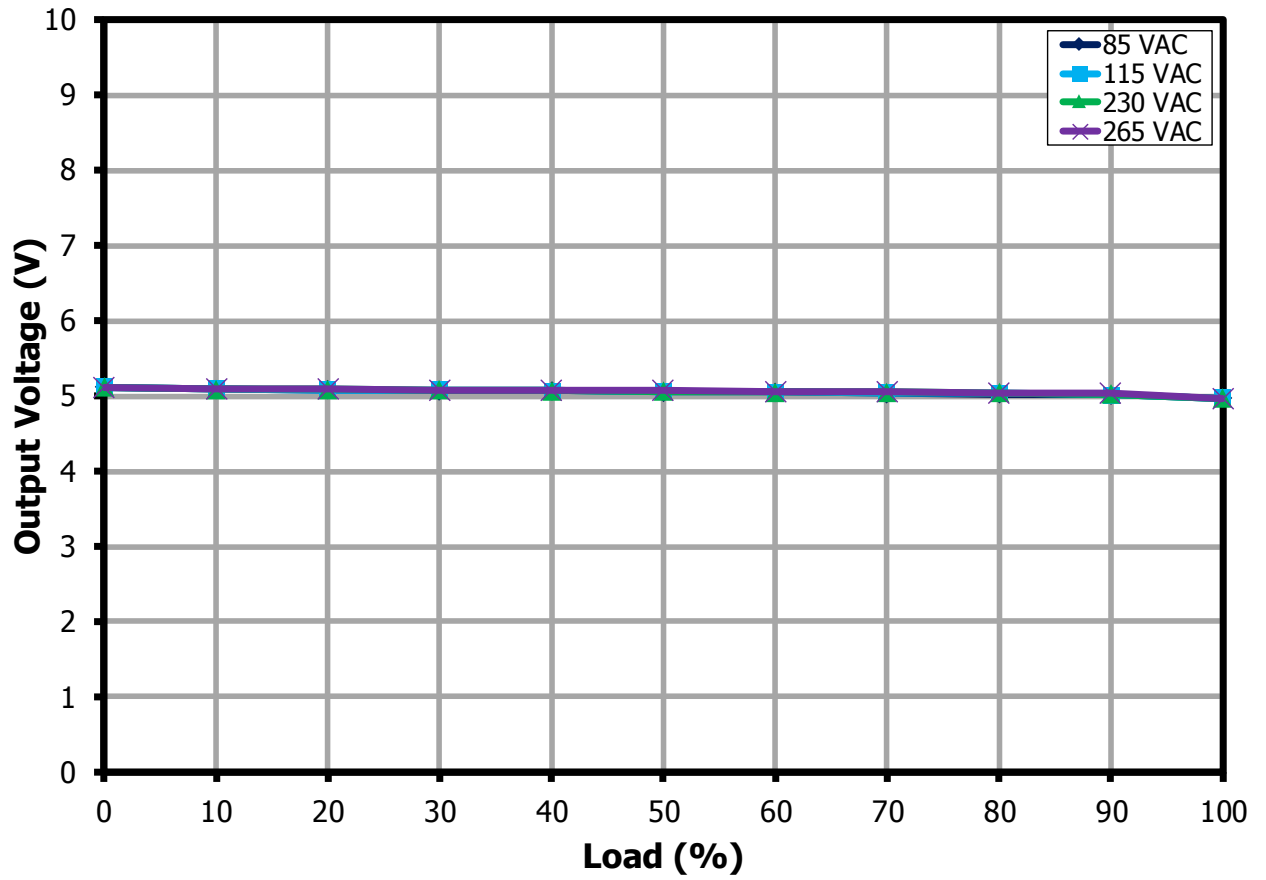

Figure 28 – Output Voltage vs. Output Load for 5 V Output, Room Temperature.



11.6.2 9.0 V Output

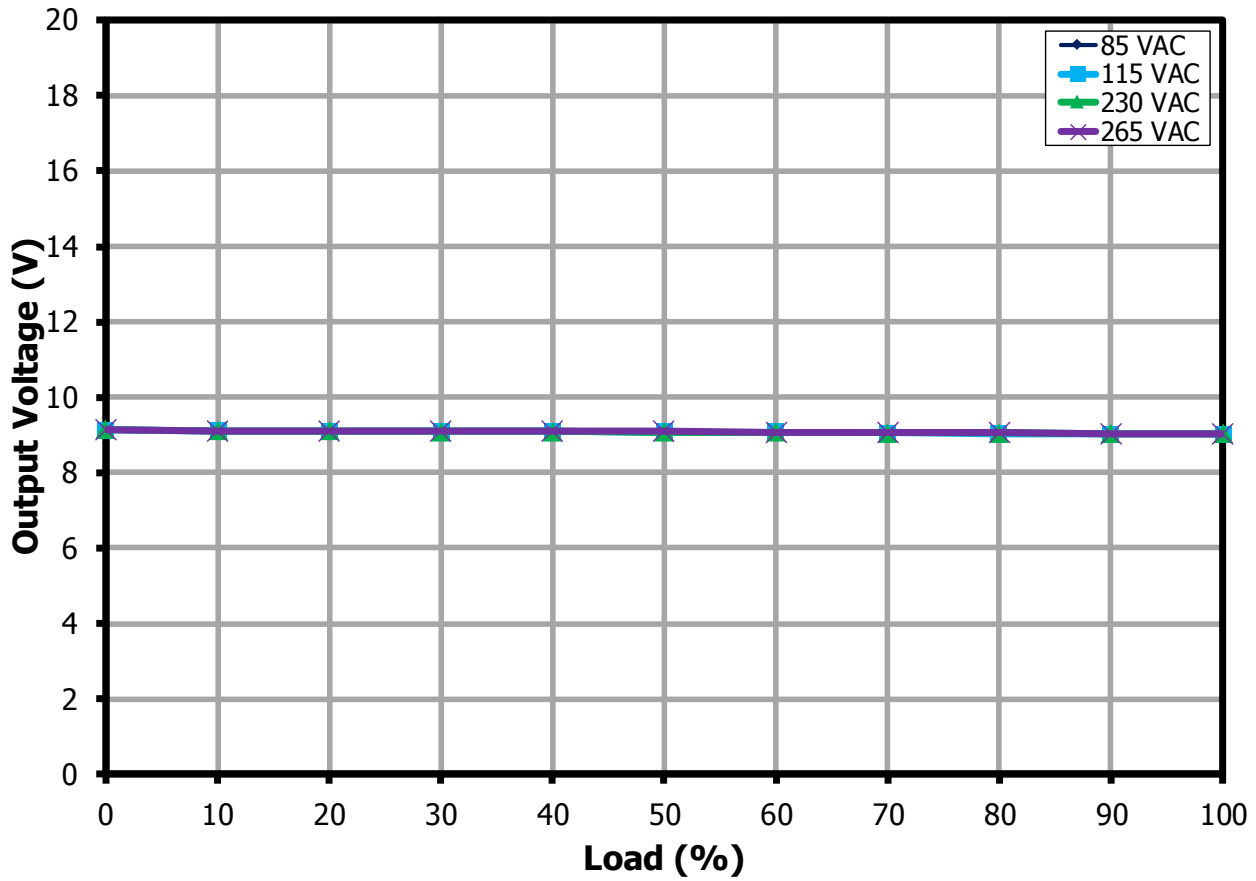

Figure 29 – Output Voltage vs. Output Load for 9 V Output, Room Temperature.

11.6.3 15.0 V Output

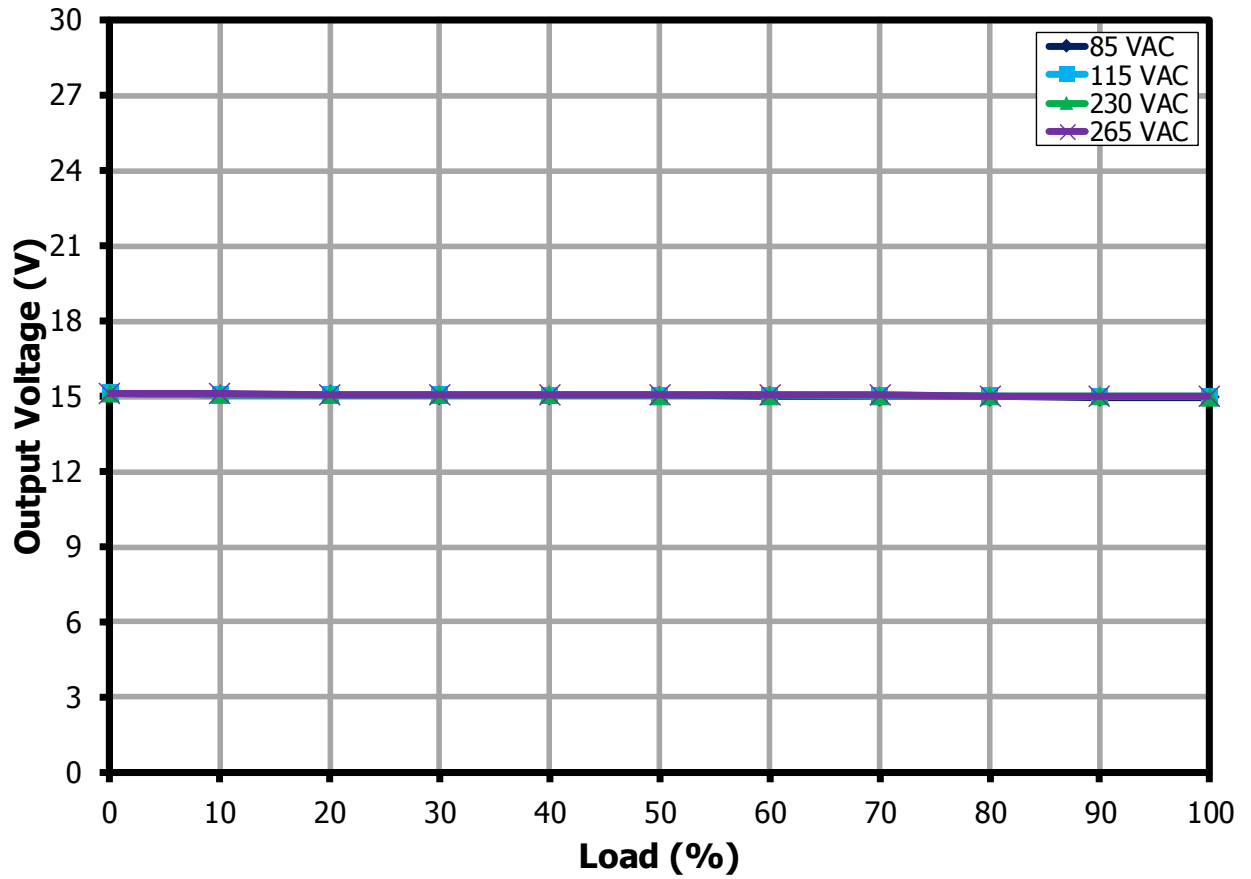

Figure 30 – Output Voltage vs. Output Load for 15 V Output, Room Temperature.



11.6.4 20.0 V Output

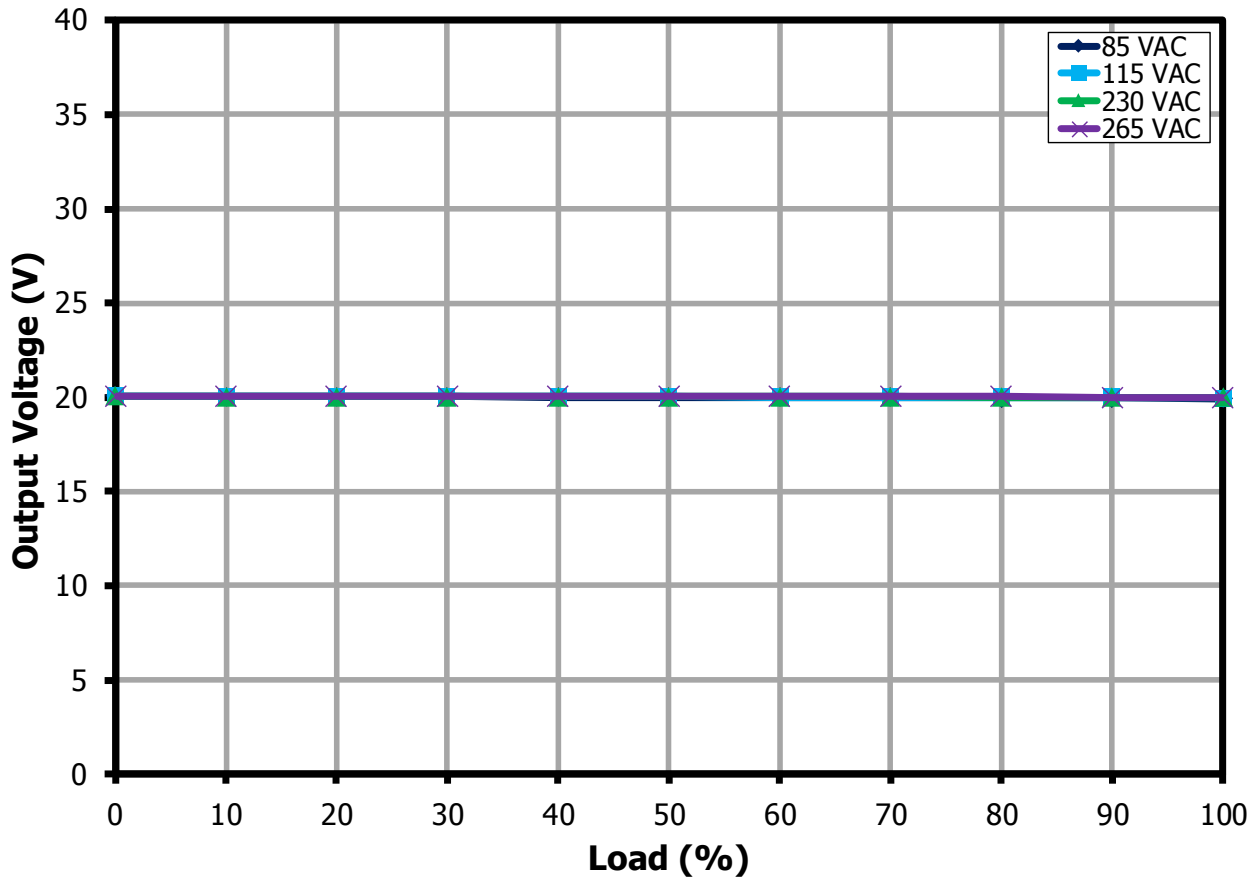

Figure 31 – Output Voltage vs. Output Load for 20 V Output, Room Temperature.

12 Thermal Performance in Open Case

Note: For plastic enclosed adapters, this design requires use of a metallic heat spreader and suitable thermally conductive insulator to ensure sufficiently low temperature of the InnoSwitch-3 Pro IC and Transformer. The performance data below is for open case operation and does not use the heat spreader for cooling.

12.1 5 V, 3 A

12.1.1 85 VAC Input

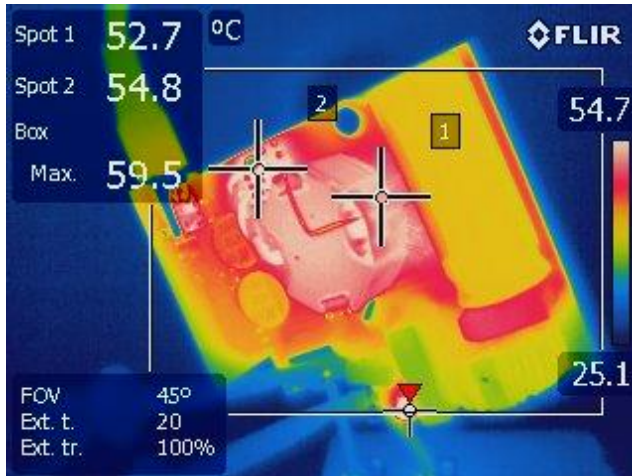

Figure 32 – Transformer Side.
Ambient = 25.3 °C.
Thermistor = 59.5 °C.
Transformer = 52.7 °C.

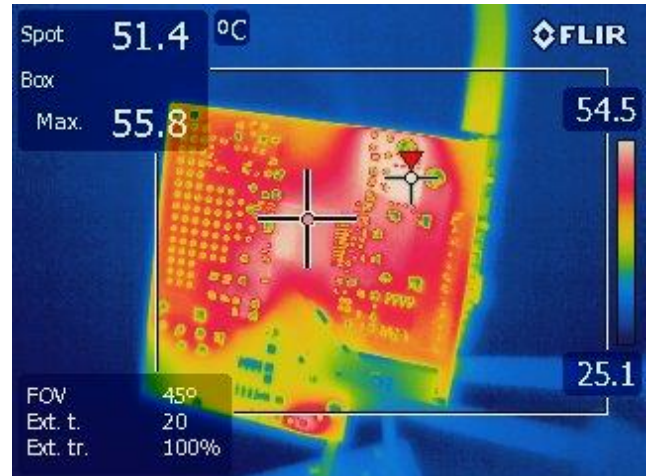

Figure 33 – InnoSwitch3-Pro Side.
Ambient = 25.3 °C.
SR FET, Q2 = 55.8 °C.
InnoSwitch3-Pro = 51.4 °C.

12.1.2 265 VAC Input

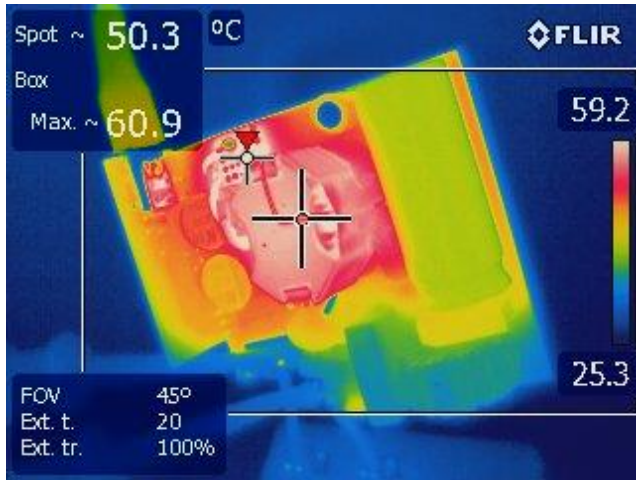

Figure 34 – Transformer Side.
Ambient = 25.8 °C.
Transformer = 50.3 °C.

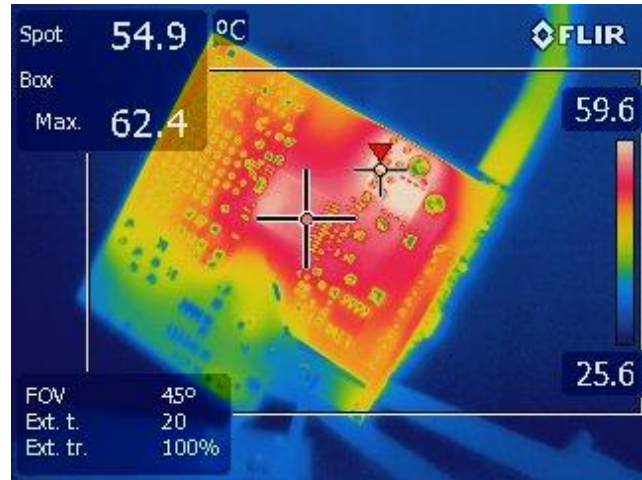

Figure 35 – InnoSwitch3-Pro Side.
Ambient = 25.8 °C.
SR FET, Q2 = 62.4 °C.
InnoSwitch3-Pro = 54.9 °C .

12.2 **9 V, 3 A**

12.2.1 85 VAC Input

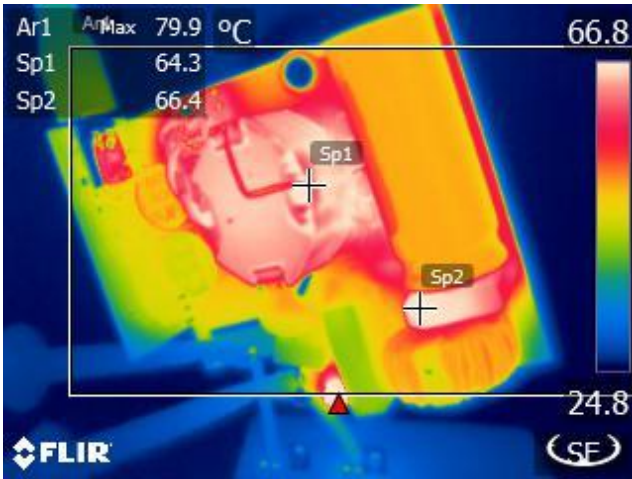

Figure 36 – Transformer Side.
 Ambient = 25.3 °C.
 Thermistor, RT1 = 79.9°C
 Transformer = 64.3 °C.

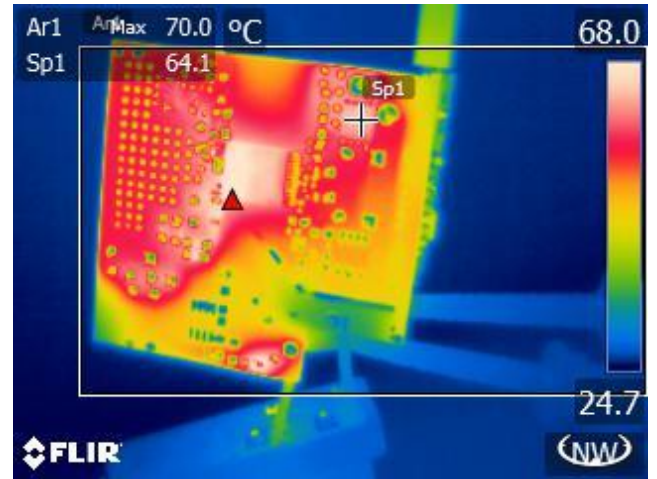

Figure 37 – InnoSwitch3-Pro Side.
 Ambient = 25.3 °C.
 InnoSwitch3-Pro = 70.0°C.
 SR FET, Q2 = 64.1 °C.

12.2.2 265 VAC Input

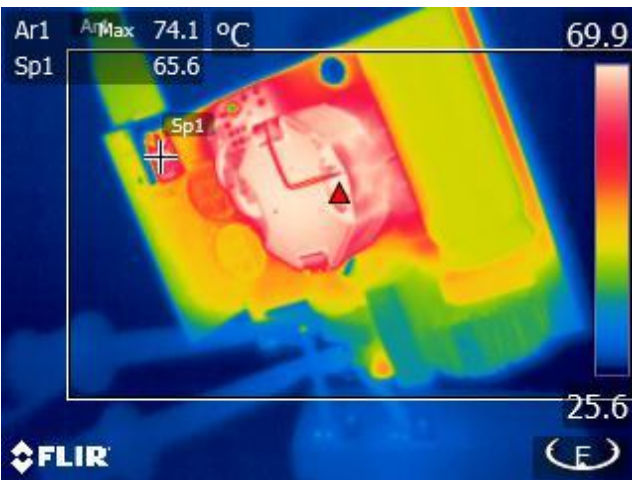

Figure 38 – Transformer Side.
 Ambient = 25.6 °C.
 Transformer = 74.1 °C.

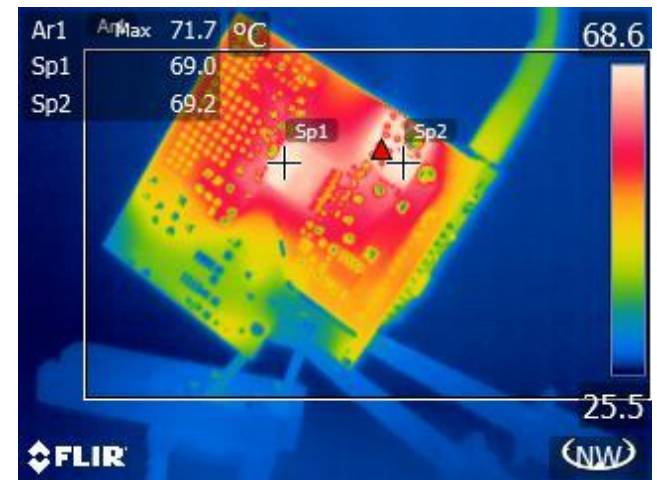

Figure 39 – InnoSwitch3-Pro Side.
 Ambient = 25.6 °C.
 InnoSwitch3-Pro = 69.0 °C.
 SRFET, Q2 = 71.7 °C.

12.3 15 V, 3 A

12.3.1 85 VAC Input

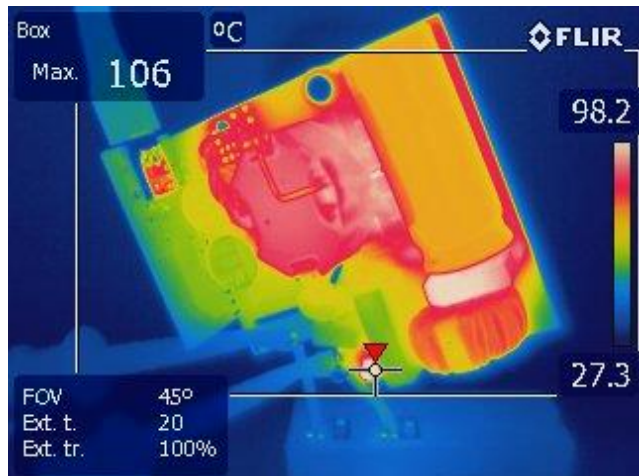

Figure 40 – Transformer Side.
 Ambient = 27.5 °C.
 Thermistor, RT1 = 106.0 °C.

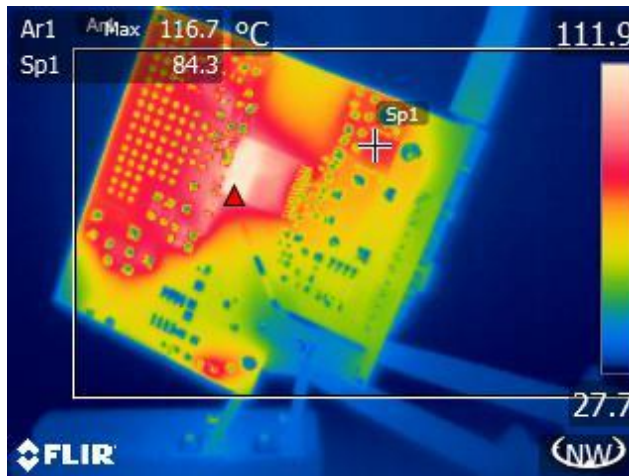

Figure 41 – InnoSwitch3-Pro Side.
 Ambient = 27.5 °C.
 InnoSwitch3-Pro = 116.7 °C.
 SR FET, Q2 = 84.3 °C.

12.3.2 265 VAC Input

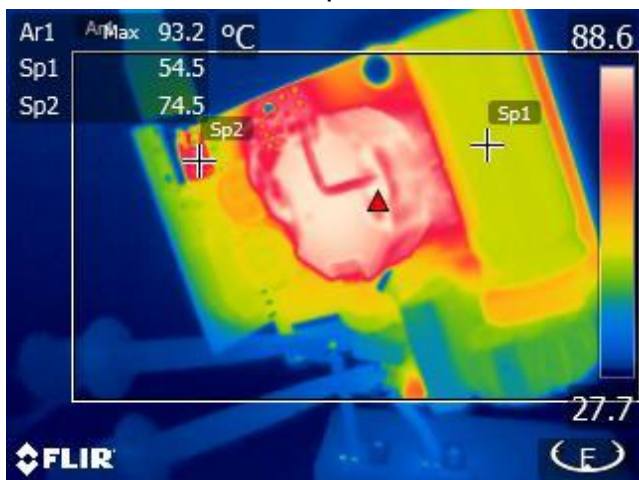

Figure 42 – Transformer Side.
 Ambient = 27.3 °C.
 Transformer = 93.2 °C.

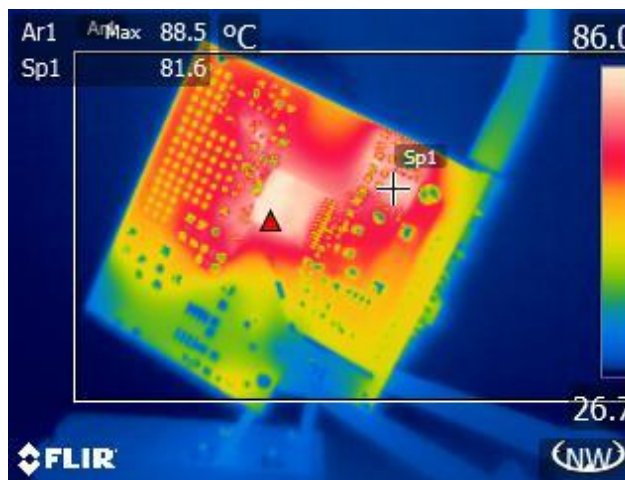

Figure 43 – InnoSwitch3-Pro Side.
 Ambient = 27.3 °C.
 InnoSwitch3-Pro = 88.5 °C.
 SR FET, Q2 = 81.6 °C.

12.4 **20 V, 2.25 A**

12.4.1 85 VAC Input

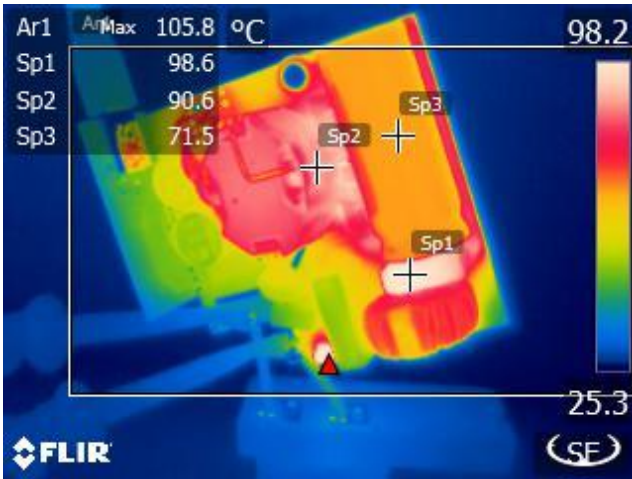

Figure 44 – Transformer Side.
 Ambient = 26.6 °C.
 Thermistor, RT1 = 105.8 °C.
 Bridge Rectifier, BR1 = 98.6 °C.

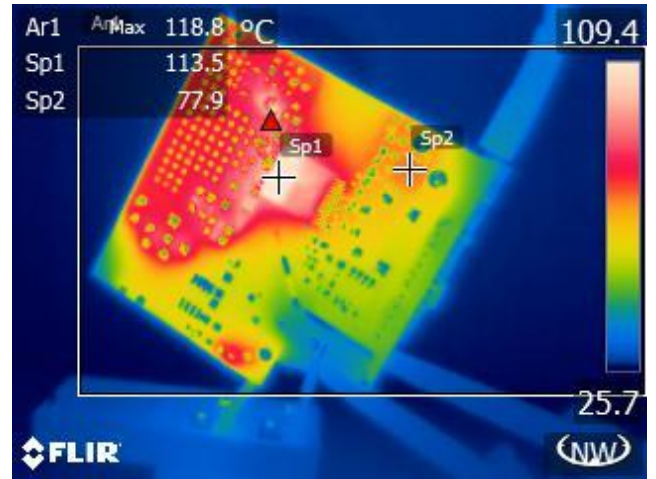

Figure 45 – InnoSwitch3-Pro Side.
 Ambient = 26.6 °C.
 InnoSwitch3-Pro = 113.5 °C.
 SR FET, Q2 = 77.9 °C.
 BJT Transistor, Q1 = 118.8 °C.

12.4.2 265 VAC Input

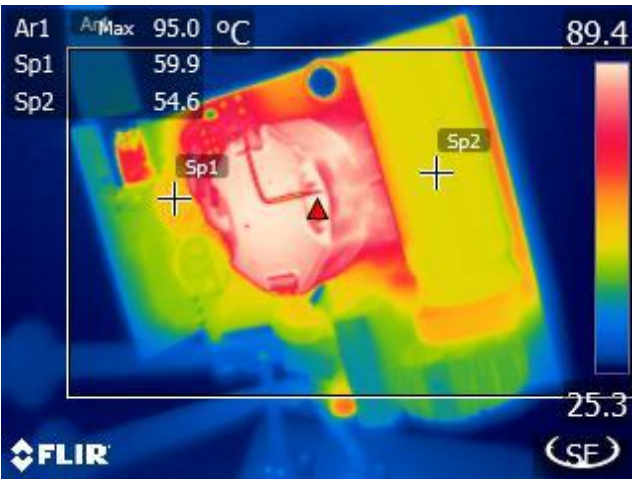

Figure 46 – Transformer Side.
 Ambient = 26.0 °C.
 Transformer = 95.0 °C.

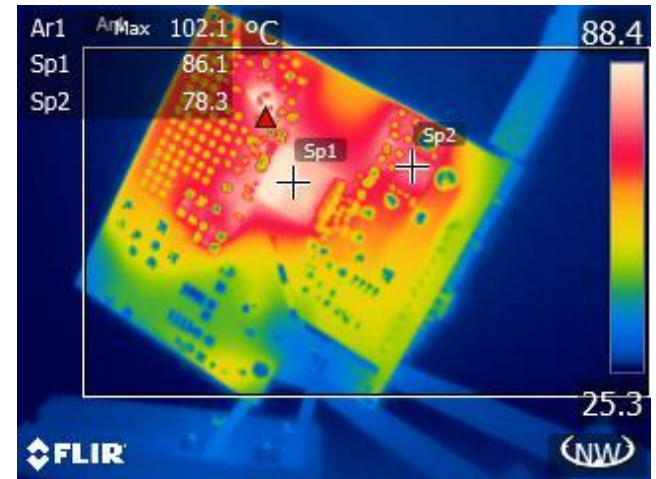

Figure 47 – InnoSwitch3-Pro Side.
 Ambient = 26.0 °C.
 BJT Transistor, Q1 = 102.1 °C,
 InnoSwitch3-Pro = 86.1 °C.
 SR FET, Q2 = 78.3 °C.

13 Waveforms

13.1 Load Transient Response

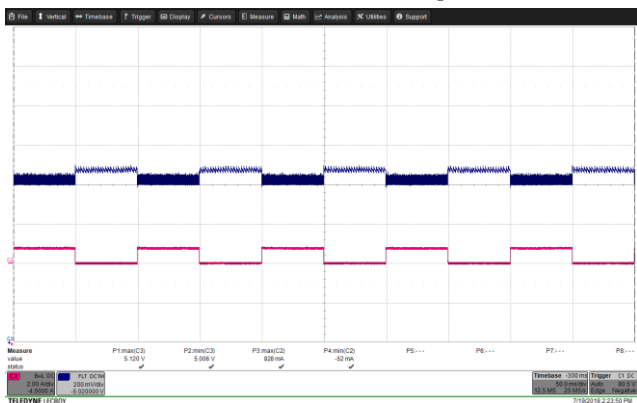

Figure 48 – Transient Response.
 85 VAC, 5.0 V, 0 – 0.75 A Load Step.
 V_{MIN} 5.006 V, V_{MAX} : 5.120 V.
 Upper: V_{OUT} , 0.2 V / div., 50 ms / div.
 Lower: I_{LOAD} , 2 A / div.

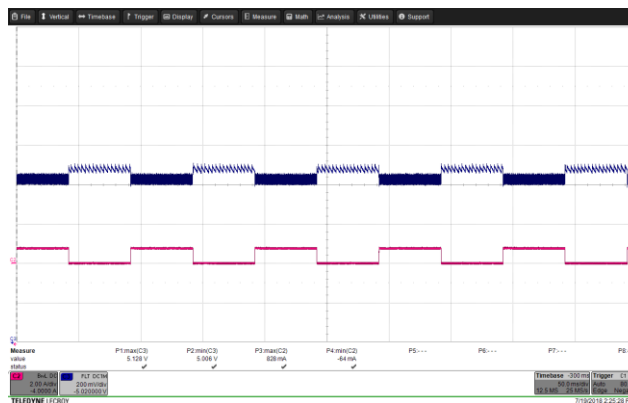

Figure 49 – Transient Response.
 265 VAC, 5.0 V, 0 – 0.75 A Load Step.
 V_{MIN} 5.006 V, V_{MAX} : 5.128 V.
 Upper: V_{OUT} , 0.2 V / div., 50 ms / div.
 Lower: I_{LOAD} , 2 A / div.

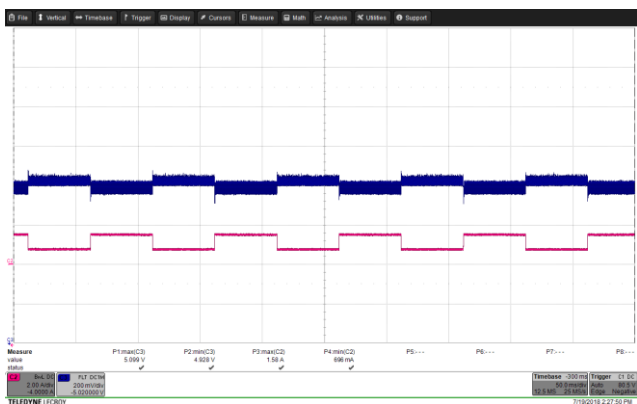

Figure 50 – Transient Response.
 85 VAC, 5.0 V, 0.75 – 1.5 A Load Step.
 V_{MIN} 4.928 V, V_{MAX} : 5.099 V.
 Upper: V_{OUT} , 0.2 V / div., 50 ms / div.
 Lower: I_{LOAD} , 2 A / div.

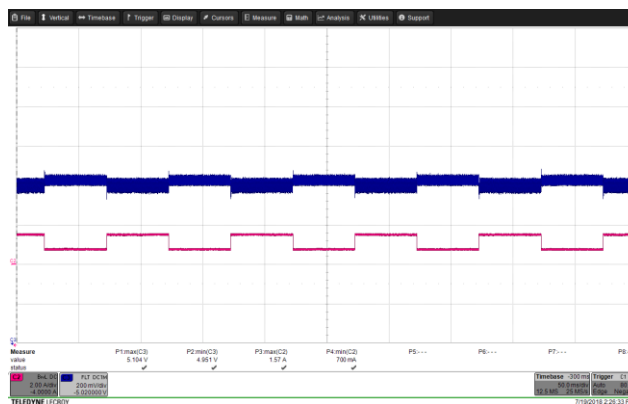

Figure 51 – Transient Response.
 265 VAC, 5.0 V, 0.75 – 1.5 A Load Step.
 V_{MIN} 4.951 V, V_{MAX} : 5.104 V.
 Upper: V_{OUT} , 0.2 V / div., 50 ms / div.
 Lower: I_{LOAD} , 2 A / div.



Figure 52 – Transient Response.
 85 VAC, 5.0 V, 1.5 – 2.25 A Load Step.
 V_{MIN} : 4.886 V, V_{MAX} : 5.073 V.
 Upper: V_{OUT} , 0.2 V / div., 50 ms / div.
 Lower: I_{LOAD} , 2 A / div.



Figure 53 – Transient Response.
 265 VAC, 5.0 V, 1.5 – 2.25 A Load Step.
 V_{MIN} : 4.904 V, V_{MAX} : 5.088 V.
 Upper: V_{OUT} , 0.2 V / div., 50 ms / div.
 Lower: I_{LOAD} , 2 A / div.

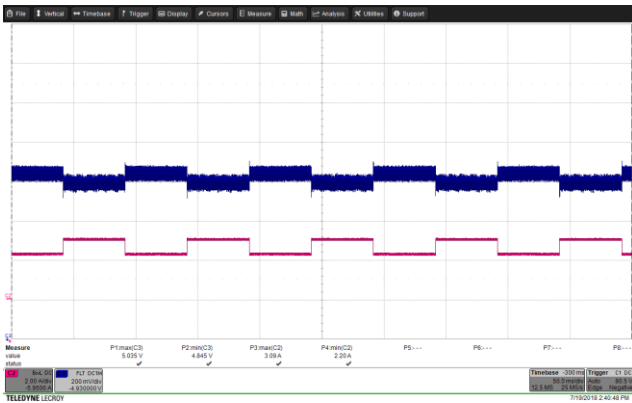

Figure 54 – Transient Response.
 85 VAC, 5.0 V, 2.25 – 3 A Load Step.
 V_{MIN} : 4.845 V, V_{MAX} : 5.035 V.
 Upper: V_{OUT} , .2 V / div., 50 ms / div.
 Lower: I_{LOAD} , 2 A / div.

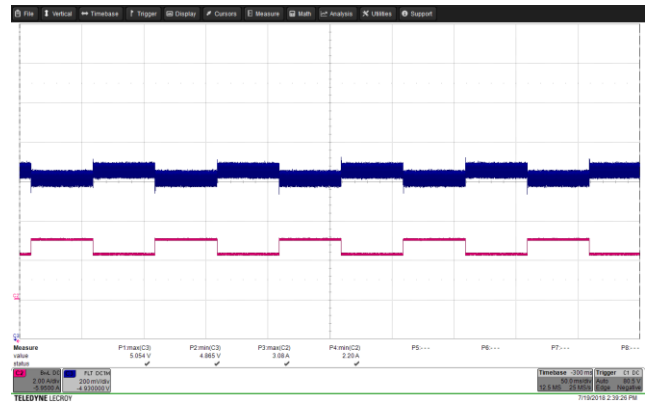

Figure 55 – Transient Response.
 265 VAC, 5.0 V, 2.25 – 3 A Load Step.
 V_{MIN} : 4.865 V, V_{MAX} : 5.054 V.
 Upper: V_{OUT} , .2 V / div., 50 ms / div.
 Lower: I_{LOAD} , 2 A / div.



Figure 56 – Transient Response.
 85 VAC, 9.0 V, 0 – 0.75 A Load Step.
 V_{MIN} 8.990 V, V_{MAX} : 9.147 V.
 Upper: V_{OUT} , 0.2 V / div., 50 ms / div.
 Lower: I_{LOAD} , 2 A / div.



Figure 57 – Transient Response.
 265 VAC, 9.0 V, 0 – 0.75 A Load Step.
 V_{MIN} 8.995 V, V_{MAX} : 9.143 V.
 Upper: V_{OUT} , 0.2 V / div., 50 ms / div.
 Lower: I_{LOAD} , 2 A / div.

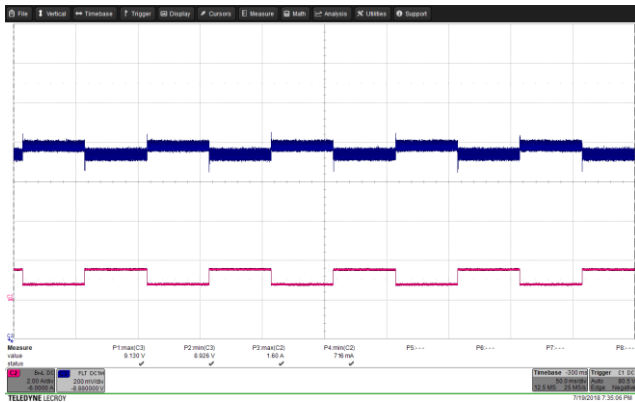

Figure 58 – Transient Response.
 85 VAC, 9.0 V, 0.75 – 1.5 A Load Step.
 V_{MIN} 8.926 V, V_{MAX} : 9.130 V.
 Upper: V_{OUT} , 0.2 V / div., 50 ms / div.
 Lower: I_{LOAD} , 2 A / div.

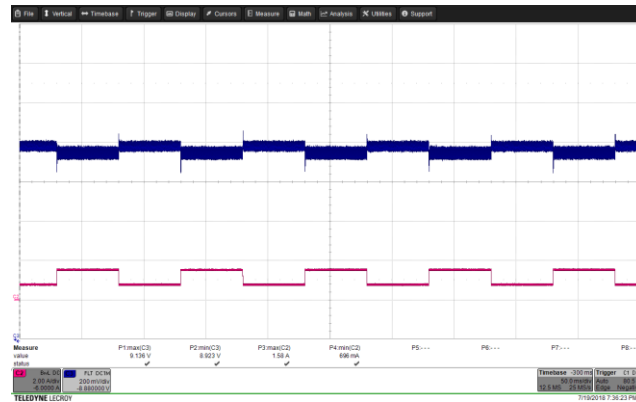

Figure 59 – Transient Response.
 265 VAC, 9.0 V, 0.75 – 1.5 A Load Step.
 V_{MIN} 8.923 V, V_{MAX} : 9.136 V.
 Upper: V_{OUT} , 0.2 V / div., 50 ms / div.
 Lower: I_{LOAD} , 2 A / div.



Figure 60 – Transient Response.
 85 VAC, 9.0 V, 1.5 – 2.25 A Load Step.
 V_{MIN} : 8.873 V, V_{MAX} : 9.092 V.
 Upper: V_{OUT} , 0.2 V / div., 50 ms / div.
 Lower: I_{LOAD} , 2 A / div.



Figure 61 – Transient Response.
 265 VAC, 9.0 V, 1.5 – 2.25 A Load Step.
 V_{MIN} : 8.886 V, V_{MAX} : 9.101 V.
 Upper: V_{OUT} , 0.2 V / div., 50 ms / div.
 Lower: I_{LOAD} , 2 A / div.

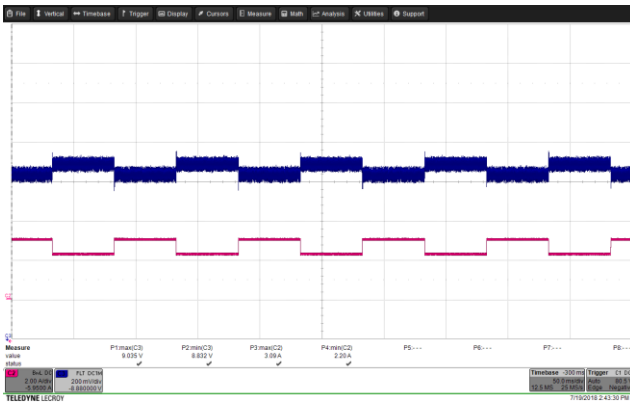

Figure 62 – Transient Response.
 85 VAC, 9.0V, 2.25 – 3 A Load Step.
 V_{MIN} : 8.832 V, V_{MAX} : 9.035 V.
 Upper: V_{OUT} , .2 V / div., 50 ms / div.
 Lower: I_{LOAD} , 2 A / div.

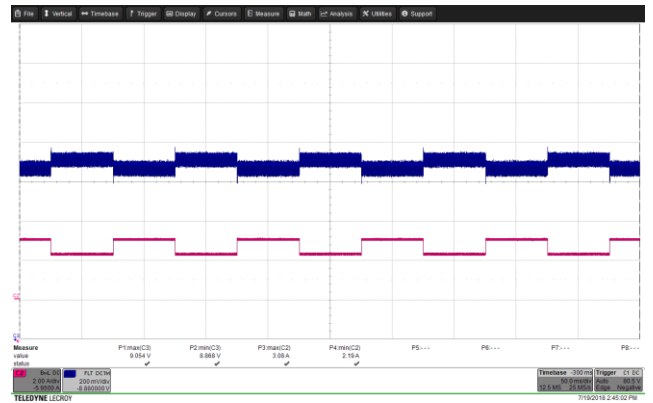

Figure 63 – Transient Response.
 265 VAC, 9.0 V, 2.25 – 3 A Load Step.
 V_{MIN} : 8.868 V, V_{MAX} : 9.054 V.
 Upper: V_{OUT} , .2 V / div., 50 ms / div.
 Lower: I_{LOAD} , 2 A / div.





Figure 64 – Transient Response.
 85 VAC, 15.0 V, 0 – 0.75 A Load Step.
 V_{MIN} 14.879 V, V_{MAX} : 15.092 V.
 Upper: V_{OUT} , 0.2 V / div., 50 ms / div.
 Lower: I_{LOAD} , 2 A / div.

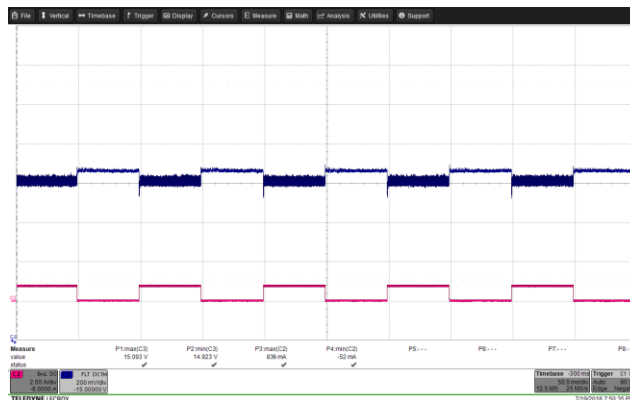

Figure 65 – Transient Response.
 265 VAC, 15.0 V, 0 – 0.75 A Load Step.
 V_{MIN} 14.923 V, V_{MAX} : 15.093 V.
 Upper: V_{OUT} , 0.2 V / div., 50 ms / div.
 Lower: I_{LOAD} , 2 A / div.

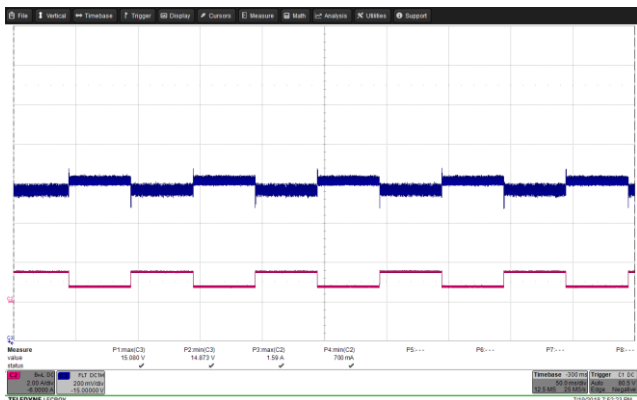

Figure 66 – Transient Response.
 85 VAC, 15.0 V, 0.75 – 1.5 A Load Step.
 V_{MIN} 14.873 V, V_{MAX} : 15.080 V.
 Upper: V_{OUT} , 0.2 V / div., 50 ms / div.
 Lower: I_{LOAD} , 2 A / div.



Figure 67 – Transient Response.
 265 VAC, 15.0 V, 0.75 – 1.5 A Load Step.
 V_{MIN} 14.879 V, V_{MAX} : 15.088 V.
 Upper: V_{OUT} , 0.2 V / div., 50 ms / div.
 Lower: I_{LOAD} , 2 A / div.

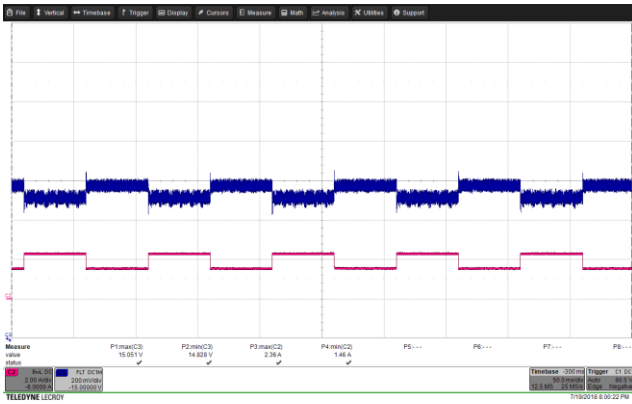

Figure 68 – Transient Response.
 85 VAC, 15 V, 1.5 – 2.25 A Load Step.
 V_{MIN} : 14.828 V, V_{MAX} : 15.051 V.
 Upper: V_{OUT} , 0.2 V / div., 50 ms / div.
 Lower: I_{LOAD} , 2 A / div.



Figure 69 – Transient Response.
 265 VAC, 15 V, 1.5 – 2.25 A Load Step.
 V_{MIN} : 14.862 V, V_{MAX} : 15.076 V.
 Upper: V_{OUT} , 0.2 V / div., 50 ms / div.
 Lower: I_{LOAD} , 2 A / div.



Figure 70 – Transient Response.
 85 VAC, 15 V, 2.25 – 3 A Load Step.
 V_{MIN} : 14.786 V, V_{MAX} : 15.051 V.
 Upper: V_{OUT} , .2 V / div., 50 ms / div.
 Lower: I_{LOAD} , 2 A / div.



Figure 71 – Transient Response.
 265 VAC, 15 V, 2.25 – 3 A Load Step.
 V_{MIN} : 14.831 V, V_{MAX} : 15.039 V.
 Upper: V_{OUT} , .2 V / div., 50 ms / div.
 Lower: I_{LOAD} , 2 A / div.



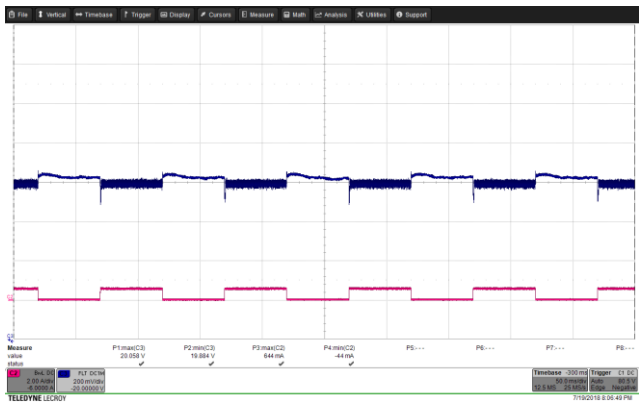

Figure 72 – Transient Response.
 85 VAC, 20.0 V, 0 – 0.56 A Load Step.
 V_{MIN} 19.884 V, V_{MAX} : 20.058 V.
 Upper: V_{OUT} , 0.2 V / div., 50 ms / div.
 Lower: I_{LOAD} , 2 A / div.



Figure 73 – Transient Response.
 265 VAC, 20.0 V, 0 – 0.56 A Load Step.
 V_{MIN} 19.898 V, V_{MAX} : 20.064 V.
 Upper: V_{OUT} , 0.2 V / div., 50 ms / div.
 Lower: I_{LOAD} , 2 A / div.

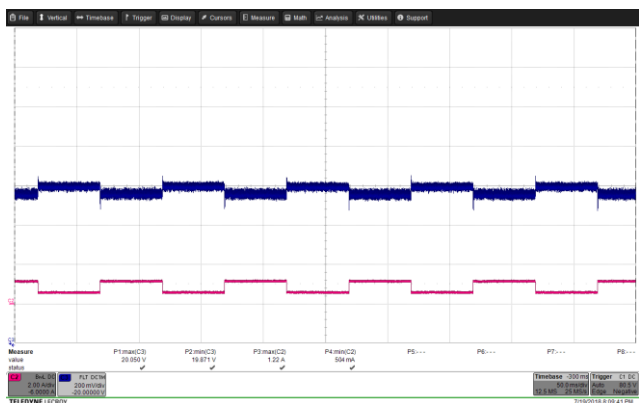

Figure 74 – Transient Response.
 85 VAC, 20.0 V, 0.56 – 1.125 A Load Step.
 V_{MIN} 19.871 V, V_{MAX} : 20.050 V.
 Upper: V_{OUT} , 0.2 V / div., 50 ms / div.
 Lower: I_{LOAD} , 2 A / div.



Figure 75 – Transient Response.
 265 VAC, 20.0 V, 0.56 – 1.125 A Load Step.
 V_{MIN} 19.893 V, V_{MAX} : 20.061 V.
 Upper: V_{OUT} , 0.2 V / div., 50 ms / div.
 Lower: I_{LOAD} , 2 A / div.



Figure 76 – Transient Response.
 85 VAC, 20.0 V, 1.125 – 1.68 A Load Step.
 V_{MIN} : 19.841 V, V_{MAX} : 20.027 V.
 Upper: V_{OUT} , 0.2 V / div., 50 ms / div.
 Lower: I_{LOAD} , 2 A / div.

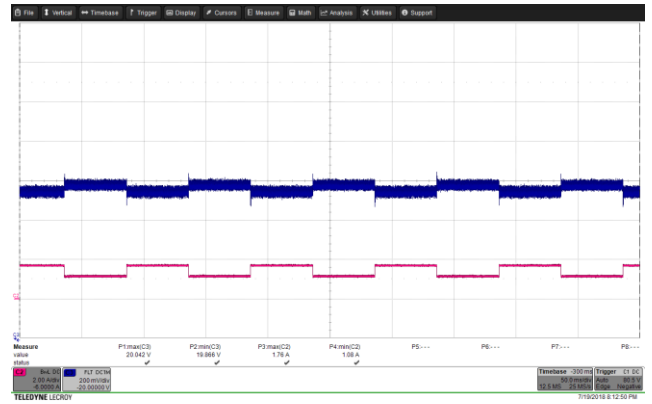

Figure 77 – Transient Response.
 265 VAC, 20.0 V, 1.125 – 1.68 A Load Step.
 V_{MIN} : 19.866 V, V_{MAX} : 20.042 V.
 Upper: V_{OUT} , 0.2 V / div., 50 ms / div.
 Lower: I_{LOAD} , 2 A / div.

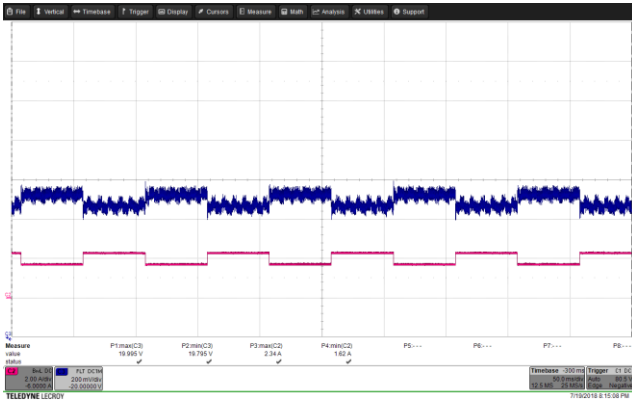

Figure 78 – Transient Response.
 85 VAC, 20.0V, 1.68 – 2.25 A Load Step.
 V_{MIN} : 19.795 V, V_{MAX} : 19.995 V.
 Upper: V_{OUT} , .2 V / div., 50 ms / div.
 Lower: I_{LOAD} , 2 A / div.

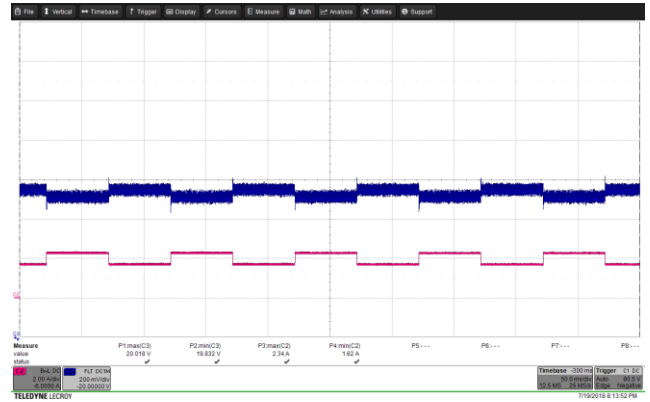

Figure 79 – Transient Response.
 265VAC, 20.0V, 1.68 – 2.25 A Load Step.
 V_{MIN} : 19.832 V, V_{MAX} : 20.018 V.
 Upper: V_{OUT} , .2 V / div., 50 ms / div.
 Lower: I_{LOAD} , 2 A / div.

13.2 Switching Waveforms

13.2.1 Primary Drain Voltage and Current

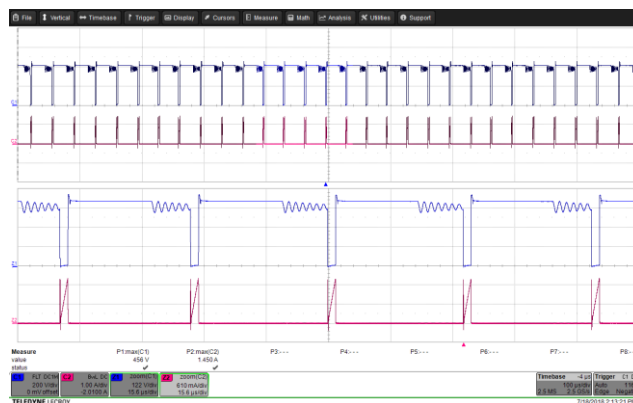
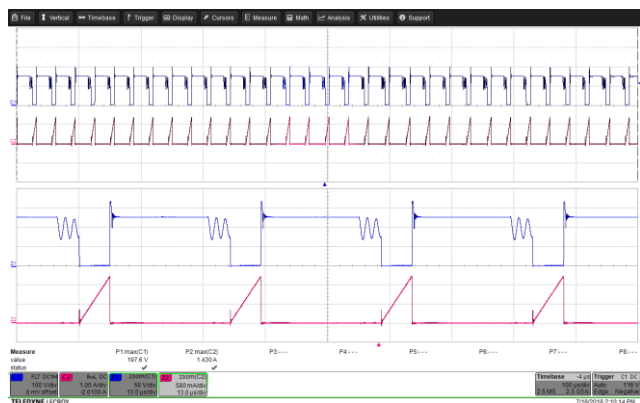

Figure 80 – Drain Voltage and Current Waveforms.
85 VAC, 5.0 V, 3 A Load (197.6 V_{MAX}).
Upper: V_{DRAIN}, 100 V, 100 μs / div.
Lower: I_{DRAIN}, 1 A / div.

Figure 81 – Drain Voltage and Current Waveforms.
265 VAC, 5.0 V, 3 A Load (456 V_{MAX}).
Upper: V_{DRAIN}, 200 V, 100 μs / div.
Lower: I_{DRAIN}, 1 A / div.

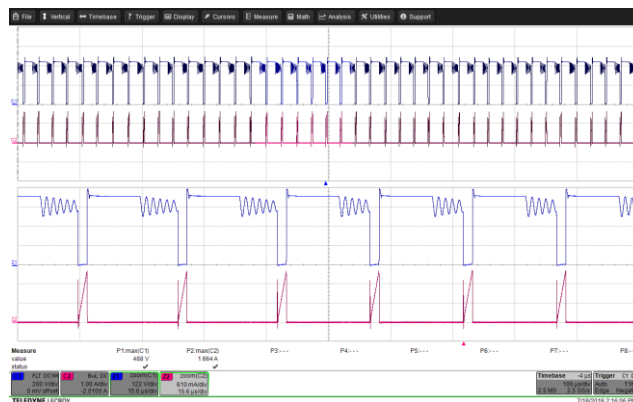
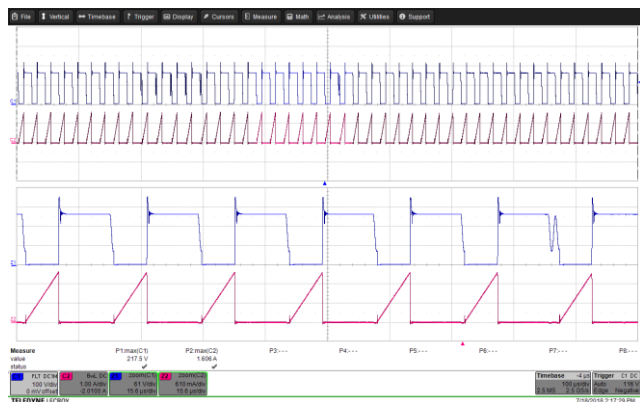

Figure 82 – Drain Voltage and Current Waveforms.
85 VAC, 9.0 V, 3 A Load (217.5 V_{MAX}).
Upper: V_{DRAIN}, 100 V, 100 μs / div.
Lower: I_{DRAIN}, 1 A / div.

Figure 83 – Drain Voltage and Current Waveforms.
265 VAC, 9 V, 3 A Load (488 V_{MAX}).
Upper: V_{DRAIN}, 200 V, 100 μs / div.
Lower: I_{DRAIN}, 1 A / div.

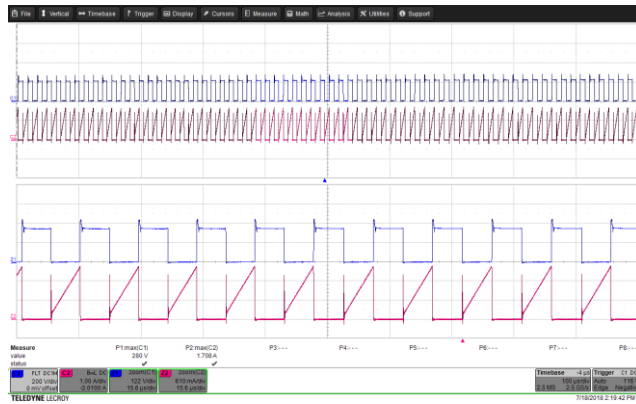

Figure 84 – Drain Voltage and Current Waveforms.
85 VAC, 15.0 V, 3 A Load (275.7 V_{MAX}).
Upper: V_{DRAIN} , 200 V, 100 μ s / div.
Lower: I_{DRAIN} , 1 A / div.

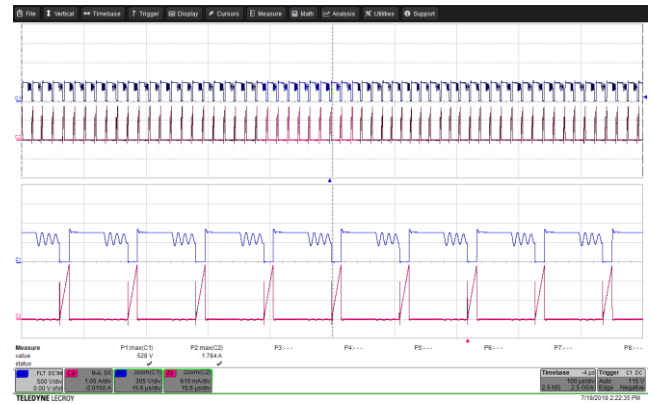

Figure 85 – Drain Voltage and Current Waveforms.
265 VAC, 15 V, 3 A Load (528 V_{MAX}).
Upper: V_{DRAIN} , 500 V, 100 μ s / div.
Lower: I_{DRAIN} , 1 A / div.

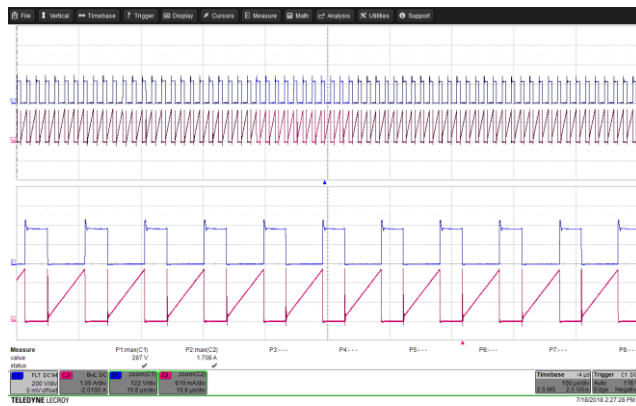

Figure 86 – Drain Voltage and Current Waveforms.
85 VAC, 20.0 V, 2.25 A Load (287 V_{MAX}).
Upper: V_{DRAIN} , 200 V, 100 μ s / div.
Lower: I_{DRAIN} , 1 A / div.

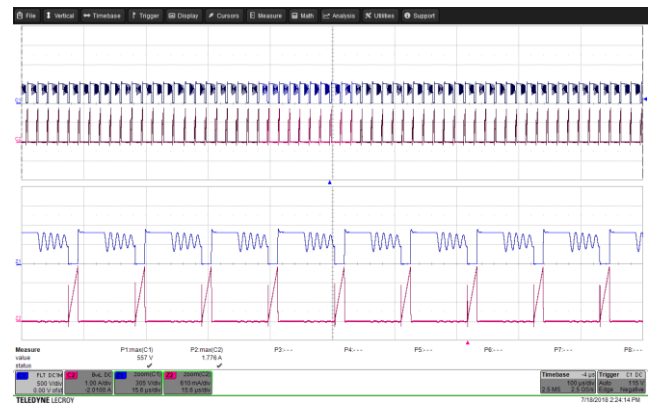

Figure 87 – Drain Voltage and Current Waveforms.
265 VAC, 20 V, 2.25 A Load (557 V_{MAX}).
Upper: V_{DRAIN} , 500 V, 100 μ s / div.
Lower: I_{DRAIN} , 1 A / div.

13.2.2 SR FET Voltage

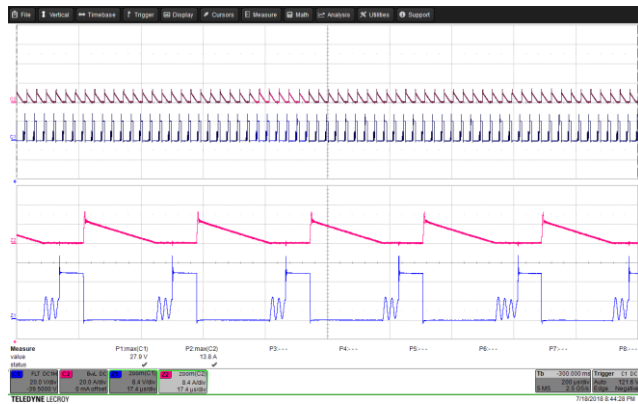

Figure 88 – SR FET Voltage Waveforms.
 85 VAC, 5.0 V, 3 A Load (27.9 V_{MAX}).
 Upper: V_{DRAIN} , 20 V, 200 μ s / div.
 Lower: I_{DRAIN} , 10 A / div.

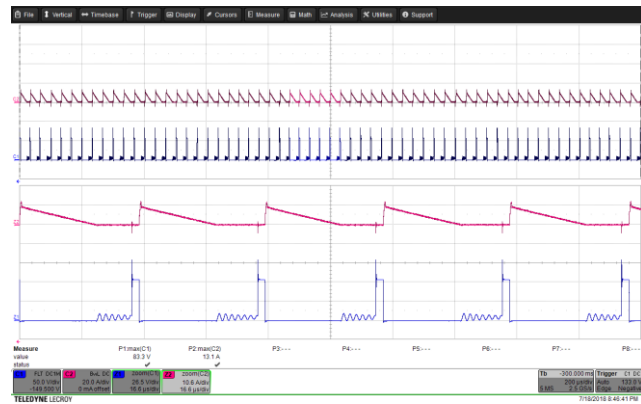

Figure 89 – SR FET Voltage Waveforms.
 265 VAC, 5.0 V, 3 A Load (83.3 V_{MAX}).
 Upper: V_{DRAIN} , 50 V, 200 μ s / div.
 Lower: I_{DRAIN} , 10 A / div.

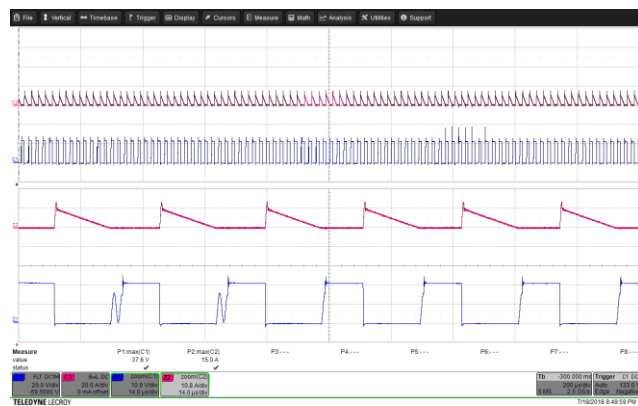

Figure 90 – SR FET Voltage Waveforms.
 85 VAC, 9.0 V, 3 A Load (37.6 V_{MAX}).
 Upper: V_{DRAIN} , 20 V, 200 μ s / div.
 Lower: I_{DRAIN} , 10 A / div.

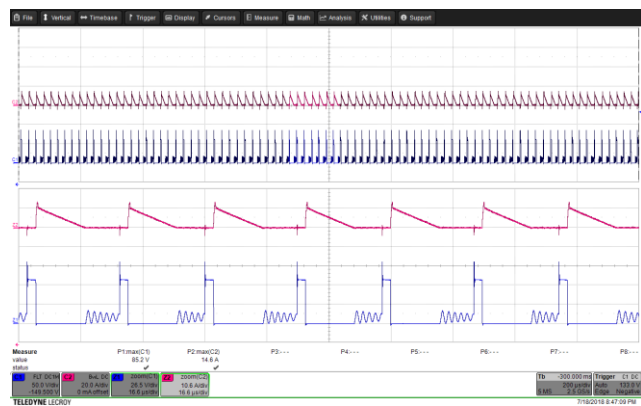

Figure 91 – SR FET Voltage Waveforms.
 265 VAC, 9.0 V, 3 A Load (85.2 V_{MAX}).
 Upper: V_{DRAIN} , 50 V, 200 μ s / div.
 Lower: I_{DRAIN} , 10 A / div.



Figure 92 – SR FET Voltage Waveforms.
 85 VAC, 15.0 V, 3 A Load (51.5 V_{MAX}).
 Upper: V_{DRAIN}, 50 V, 200 μs / div.
 Lower: I_{DRAIN}, 10 A / div.

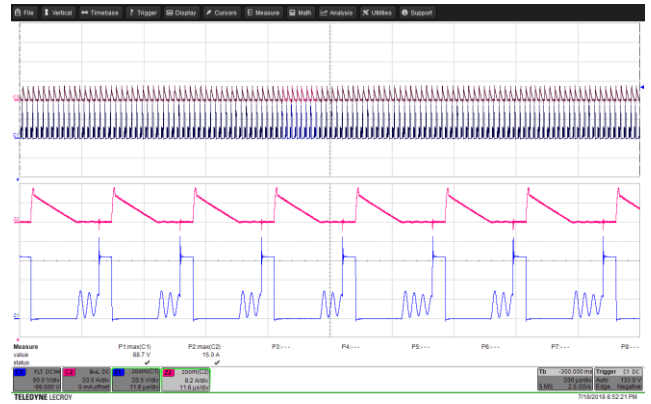

Figure 93 – SR FET Voltage Waveforms.
 265 VAC, 15.0 V, 3 A Load (88.7 V_{MAX}).
 Upper: V_{DRAIN}, 50 V, 200 μs / div.
 Lower: I_{DRAIN}, 10 A / div.



Figure 94 – SR FET Voltage Waveforms.
 85 VAC, 20.0 V, 2.25 A Load (57.3 V_{MAX}).
 Upper: V_{DRAIN}, 50 V, 200 μs / div.
 Lower: I_{DRAIN}, 10 A / div.

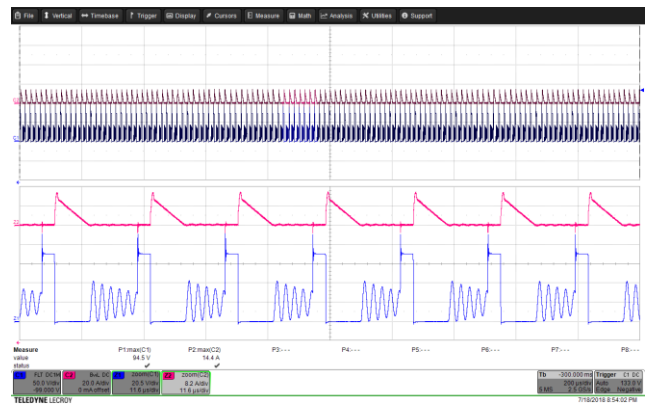

Figure 95 – SR FET Voltage Waveforms.
 265 VAC, 20.0 V, 2.25 A Load (94.5 V_{MAX}).
 Upper: V_{DRAIN}, 50 V, 200 μs / div.
 Lower: I_{DRAIN}, 10 A / div.



13.3 Start-up

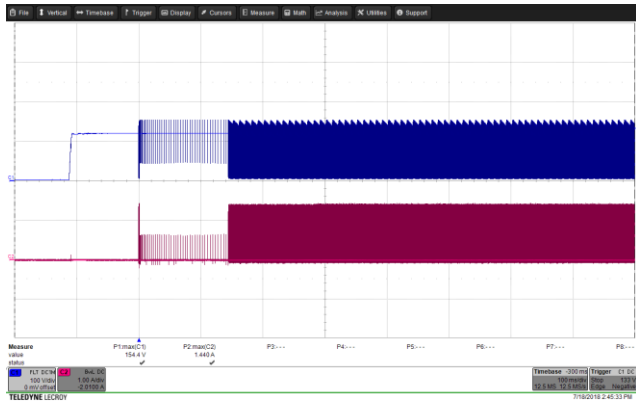

Figure 96 – Drain Voltage and Current Waveforms.
 85 VAC, 5.0 V, 3 A Load (154.7 V_{MAX}).
 Upper: V_{DRAIN} , 100 V, 100 ms / div.
 Lower: I_{DRAIN} , 1 A / div.

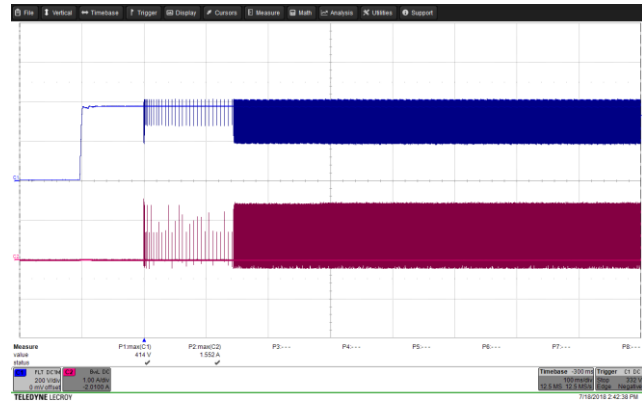

Figure 97 – Drain Voltage and Current Waveforms.
 265 VAC, 5.0 V, 3 A Load (414.0 V_{MAX}).
 Upper: V_{DRAIN} , 200 V, 100 ms / div.
 Lower: I_{DRAIN} , 1 A / div.

13.4 **Output Ripple Measurements**

13.4.1 Ripple Measurement Technique

For DC output ripple measurements, a modified oscilloscope test probe must be utilized in order to reduce spurious signals due to pick-up. Details of the probe modification are provided in the Figures below.

The 4987BA probe adapter is affixed with two capacitors tied in parallel across the probe tip. The capacitors include one (1) 0.1 $\mu\text{F}/50\text{ V}$ ceramic type and one (1) 47 $\mu\text{F}/50\text{ V}$ aluminum electrolytic. The aluminum electrolytic type capacitor is polarized, so proper polarity across DC outputs must be maintained (see below).

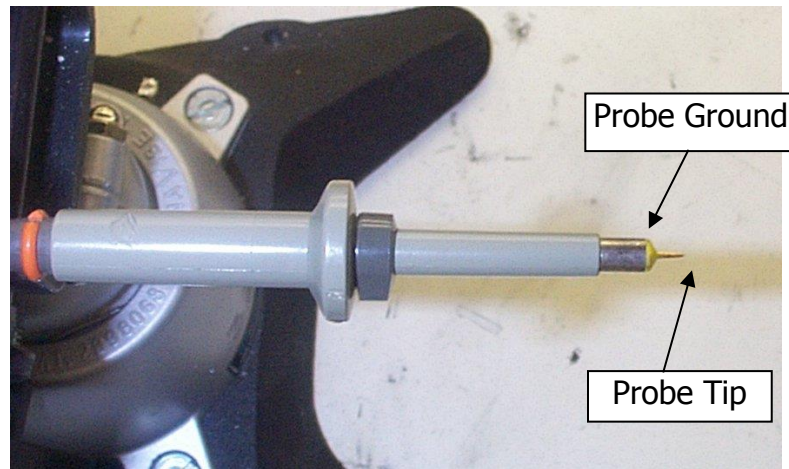

Figure 98 – Oscilloscope Probe Prepared for Ripple Measurement. (End Cap and Ground Lead Removed)



Figure 99 – Oscilloscope Probe with Probe Master (www.probemaster.com) 4987A BNC Adapter. (Modified with wires for ripple measurement, and two parallel decoupling capacitors added)

13.4.1.1 5 V (End of Type C Cable)

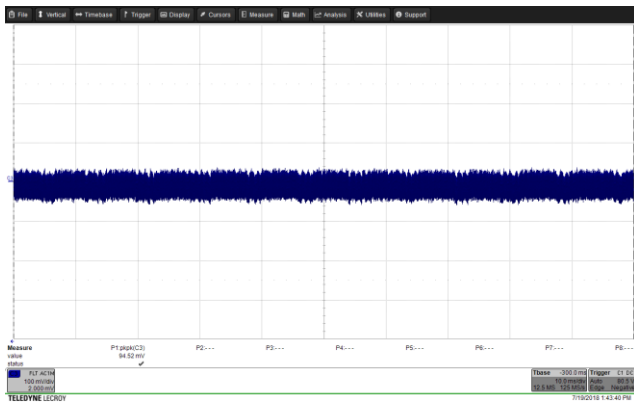

Figure 100 – Output Ripple. PK-PK = 94.52 mV.
85 VAC_{IN} 5.0 V, 3 A Load.
V_{OUT}, 100 mV / div., 10 ms / div.

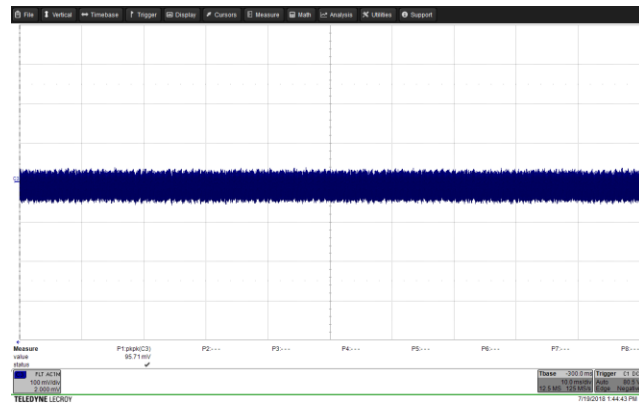

Figure 101 – Output Ripple. PK-PK = 95.71 mV.
265 VAC_{IN} 5.0 V, 3 A Load.
V_{OUT}, 100 mV / div., 10 ms / div.

13.4.1.2 9 V (End of Type C Cable)

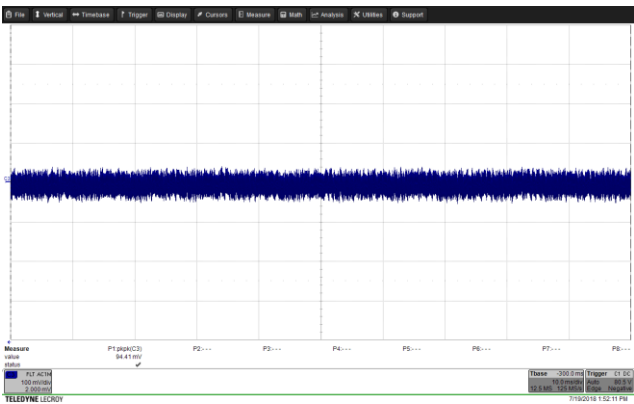

Figure 102 – Output Ripple. PK-PK = 94.41 mV.
85 VAC_{IN} 9.0 V, 3 A Load.
V_{OUT}, 100 mV / div., 10 ms / div.

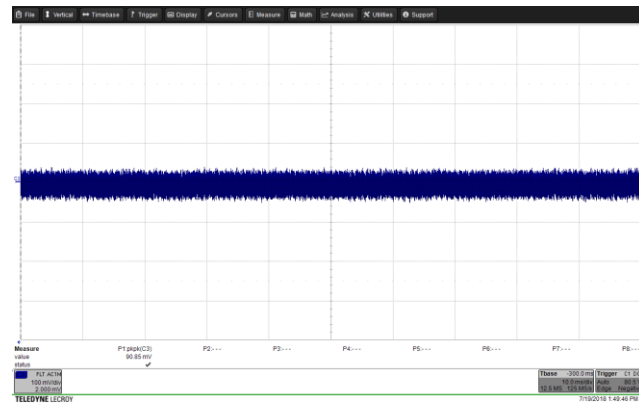

Figure 103 – Output Ripple. PK-PK = 90.85 mV.
265 VAC_{IN} 9.0 V, 3 A Load.
V_{OUT}, 100 mV / div., 10 ms / div.

13.4.1.3 15 V (End of Type C Cable)

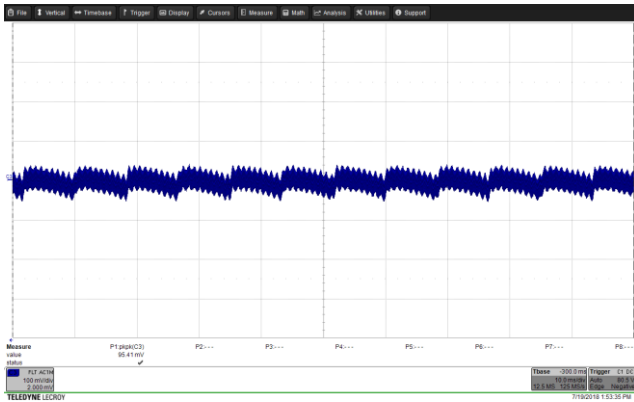

Figure 104 – Output Ripple. PK-PK = 95.41 mV.
85 VAC_{IN}, 15.0 V, 3 A Load.
V_{OUT}, 100 mV / div., 10 ms / div.

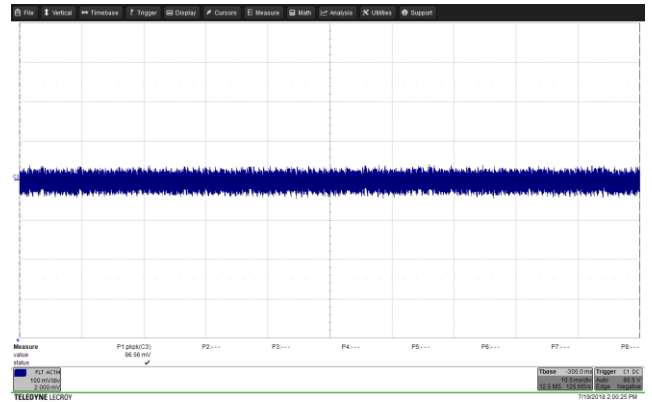

Figure 105 – Output Ripple. PK-PK = 86.56 mV.
265 VAC_{IN} 15.0 V, 3 A Load.
V_{OUT}, 100 mV / div., 10 ms / div.

13.4.1.4 20 V (End of Type C Cable)

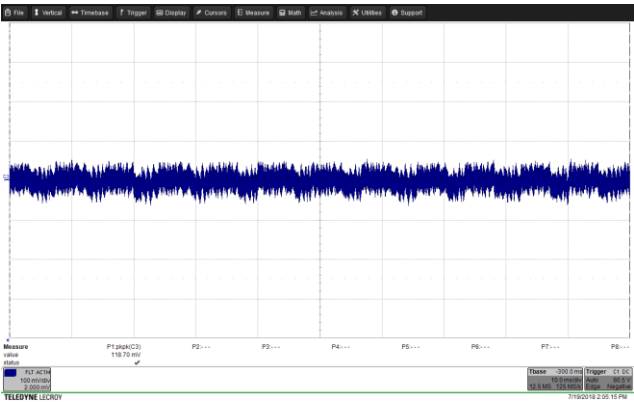

Figure 106 – Output Ripple. PK-PK = 118.70 mV.
85 VAC_{IN}, 20.0 V, 2.25 A Load.
V_{OUT}, 100 mV / div., 10 ms / div.

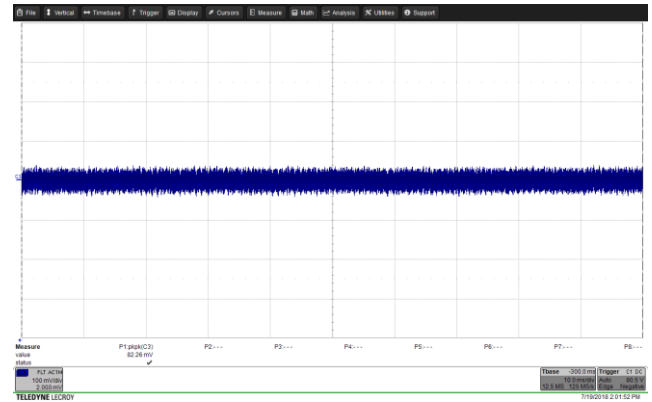

Figure 107 – Output Ripple. PK-PK = 82.26 mV.
265 VAC_{IN} 20.0 V, 2.25 A Load.
V_{OUT}, 100 mV / div., 10 ms / div.



14 CV/CC Profile

Note:

- 1. Voltage is measured at the end of cable. Drop in voltage is due to cable drop
- 2. Positive slope in CC region is per the guidelines of USB PD3.0 PPS Specification

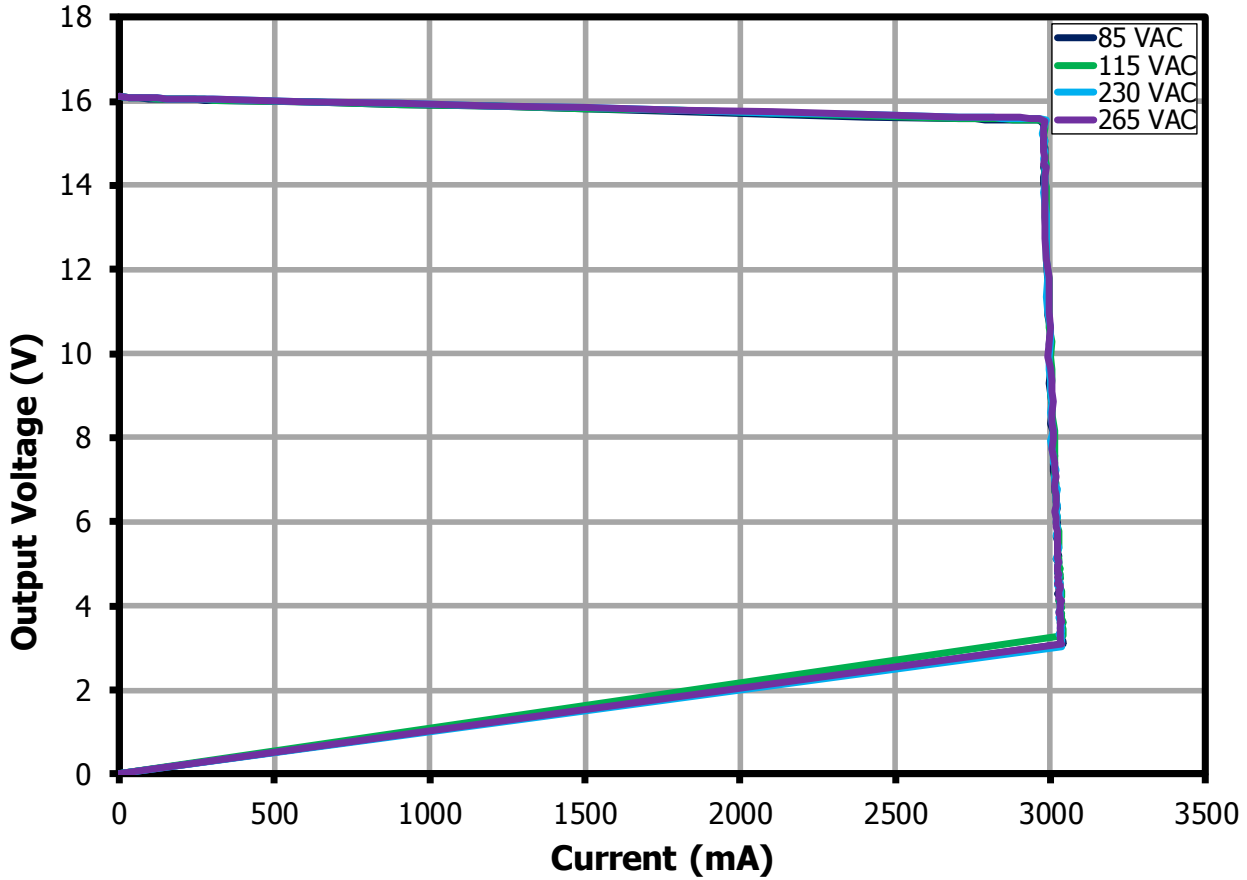

Figure 108 – CV/CC Profile with output 16 V, 3 A.



15 Voltage and Current Step Test using Quadramax and Total Phase Analyzer

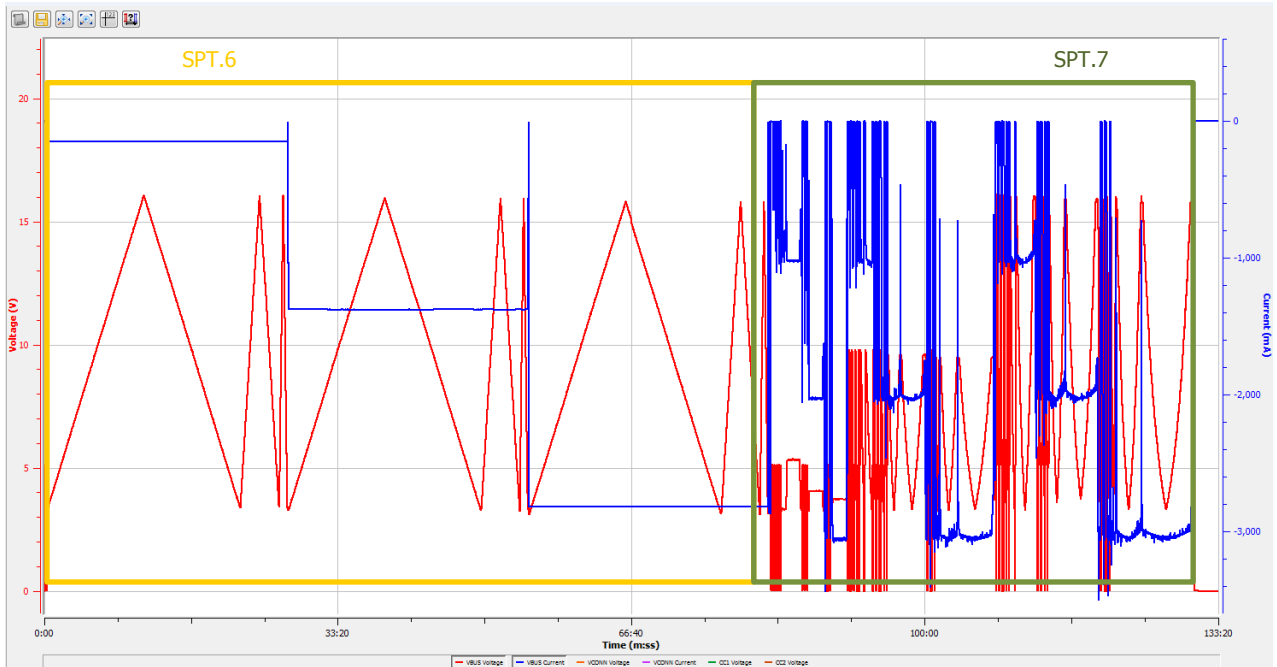

Figure 109 – Plot of SPT.6 VST Test and SPT.7 CLT Test from Total Phase Analyzer.

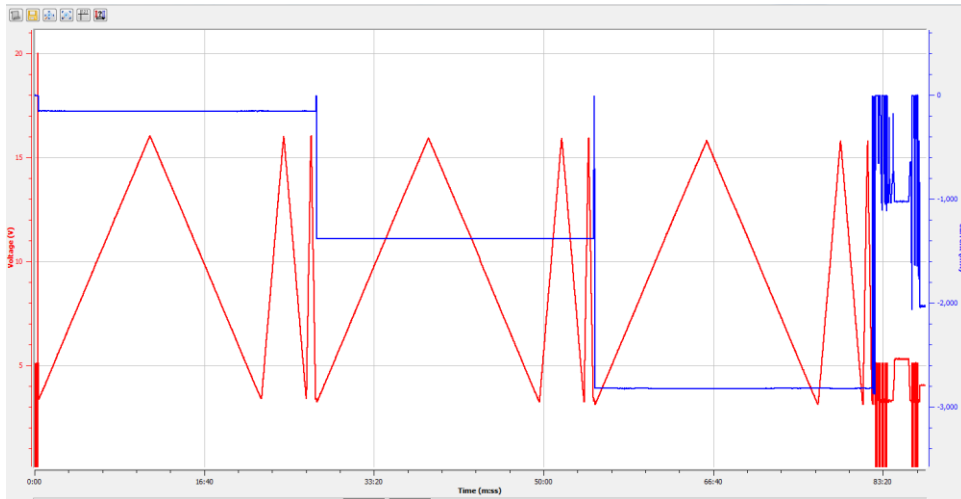

Figure 110 – Plot of SPT.6 VST Test from Total Phase Analyzer.

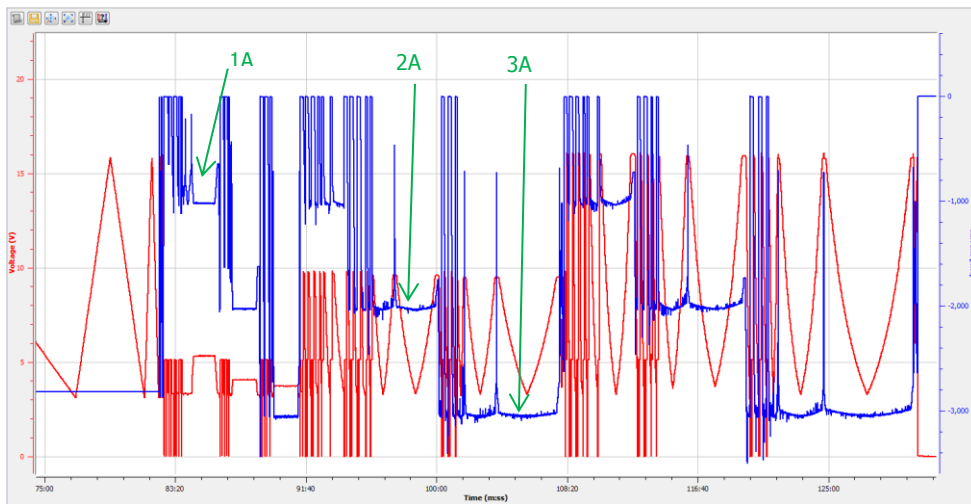
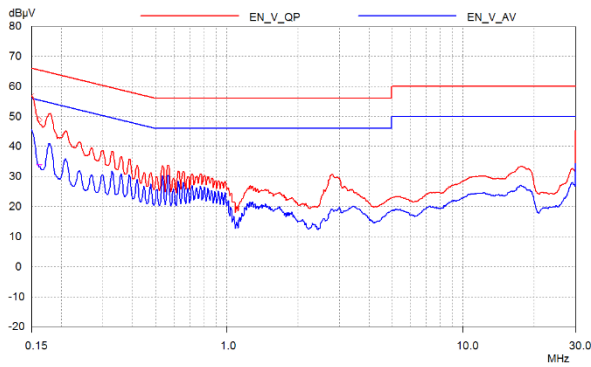

Figure 111 – Plot of SPT.7 CLT Test from Total Phase Analyzer.

16 Conducted EMI

16.1 Floating Output (QPK / AV)

16.1.1 5 V, 3 A



115 VAC_{IN}.

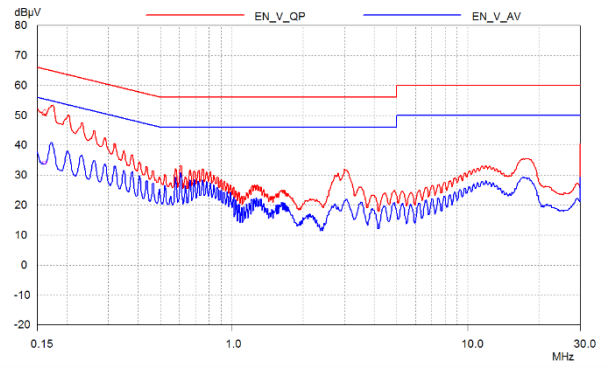

230 VAC_{IN}.

Figure 112 – Floating Ground EMI, 5 V / 3 A Load [Line Scan].

16.1.2 9 V, 3 A

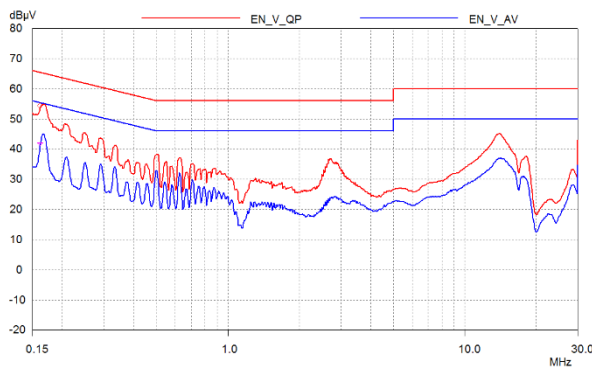

115 VAC_{IN}.

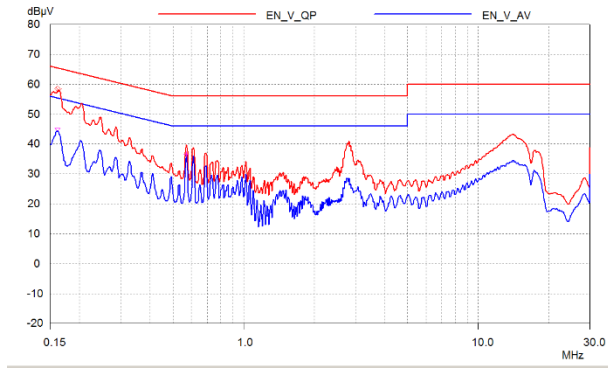

230 VAC_{IN}.

Figure 113 – Floating Ground EMI, 9 V / 3 A Load [Line Scan].



16.1.3 15 V, 3 A

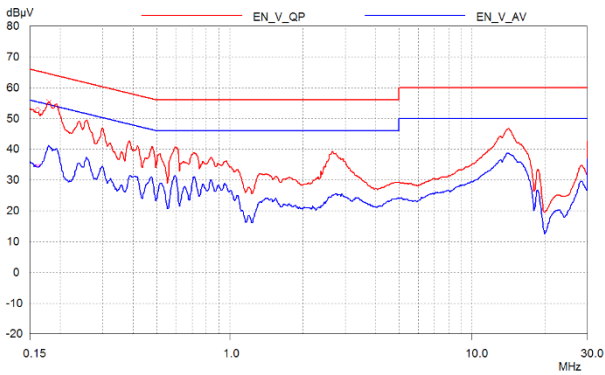

115 VAC_{IN}.

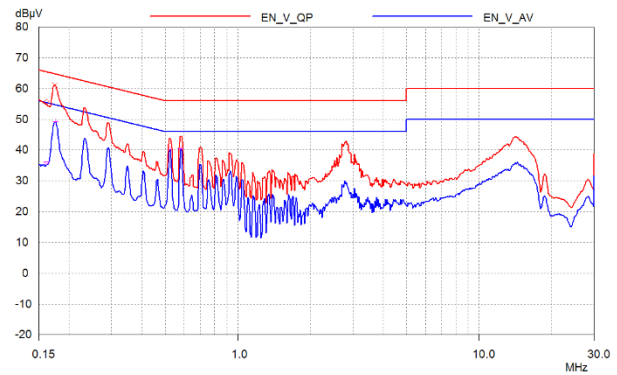

230 VAC_{IN}.

Figure 114 – Floating Ground EMI, 3 V / 3 A Load [Line Scan].

16.1.4 20 V, 2.25 A

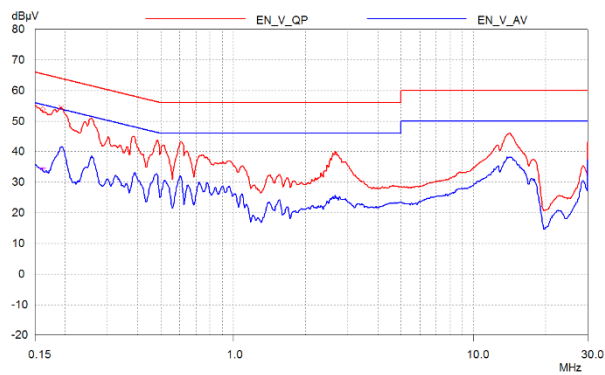

115 VAC_{IN}.

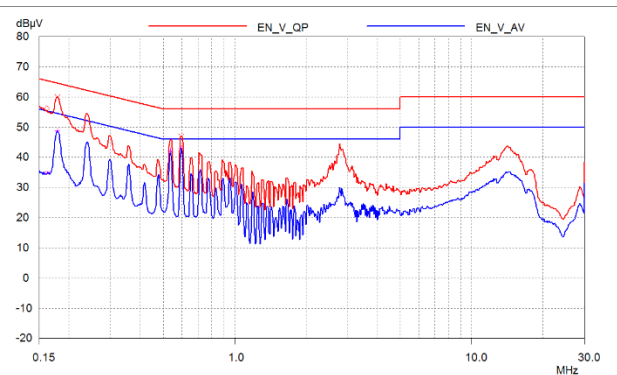

230 VAC_{IN}.

Figure 115 – Floating Ground EMI, 11 V / 2.45 A Load [Line Scan].

17 Revision History

Date	Author	Revision	Description & Changes	Reviewed
09-Aug-18	SA	1.1	Initial Release.	Apps & Mktg
05-Oct-18	SA	1.2	Updated PCB Section.	



For the latest updates, visit our website: www.power.com

Reference Designs are technical proposals concerning how to use Power Integrations' gate drivers in particular applications and/or with certain power modules. These proposals are "as is" and are not subject to any qualification process. The suitability, implementation and qualification are the sole responsibility of the end user. The statements, technical information and recommendations contained herein are believed to be accurate as of the date hereof. All parameters, numbers, values and other technical data included in the technical information were calculated and determined to our best knowledge in accordance with the relevant technical norms (if any). They may base on assumptions or operational conditions that do not necessarily apply in general. We exclude any representation or warranty, express or implied, in relation to the accuracy or completeness of the statements, technical information and recommendations contained herein. No responsibility is accepted for the accuracy or sufficiency of any of the statements, technical information, recommendations or opinions communicated and any liability for any direct, indirect or consequential loss or damage suffered by any person arising therefrom is expressly disclaimed.

Power Integrations reserves the right to make changes to its products at any time to improve reliability or manufacturability. Power Integrations does not assume any liability arising from the use of any device or circuit described herein. POWER INTEGRATIONS MAKES NO WARRANTY HEREIN AND SPECIFICALLY DISCLAIMS ALL WARRANTIES INCLUDING, WITHOUT LIMITATION, THE IMPLIED WARRANTIES OF MERCHANTABILITY, FITNESS FOR A PARTICULAR PURPOSE, AND NON-INFRINGEMENT OF THIRD PARTY RIGHTS.

Patent Information

The products and applications illustrated herein (including transformer construction and circuits' external to the products) may be covered by one or more U.S. and foreign patents, or potentially by pending U.S. and foreign patent applications assigned to Power Integrations. A complete list of Power Integrations' patents may be found at www.power.com. Power Integrations grants its customers a license under certain patent rights as set forth at <http://www.power.com/ip.htm>.

The PI Logo, TOPSwitch, TinySwitch, LinkSwitch, LYTSwitch, InnoSwitch, DPA-Switch, PeakSwitch, CAPZero, SENZero, LinkZero, HiperPFS, HiperTFS, HiperLCS, Qspeed, EcoSmart, Clampless, E-Shield, Filterfuse, FluxLink, StackFET, PI Expert and PI FACTS are trademarks of Power Integrations, Inc. Other trademarks are property of their respective companies. ©Copyright 2015 Power Integrations, Inc.

Power Integrations Worldwide Sales Support Locations**WORLD HEADQUARTERS**

5245 Hellyer Avenue
San Jose, CA 95138, USA.
Main: +1-408-414-9200
Customer Service:
Phone: +1-408-414-9665
Fax: +1-408-414-9765
e-mail: usasales@power.com

GERMANY

(IGBT Driver Sales)
HellwegForum 1
59469 Ense, Germany
Tel: +49-2938-64-39990
Email: igbt-driver.sales@power.com

KOREA

RM 602, 6FL
Korea City Air Terminal B/D,
159-6
Samsung-Dong, Kangnam-Gu,
Seoul, 135-728 Korea
Phone: +82-2-2016-6610
Fax: +82-2-2016-6630
e-mail: koreasales@power.com

CHINA (SHANGHAI)

Rm 2410, Charity Plaza, No.
88,
North Caoxi Road,
Shanghai, PRC 200030
Phone: +86-21-6354-6323
Fax: +86-21-6354-6325
e-mail:
chinasales@power.com

INDIA

#1, 14th Main Road
Vasanthanagar
Bangalore-560052
India
Phone: +91-80-4113-8020
Fax: +91-80-4113-8023
e-mail:
indiasales@power.com

SINGAPORE

51 Newton Road,
#19-01/05 Goldhill Plaza
Singapore, 308900
Phone: +65-6358-2160
Fax: +65-6358-2015
e-mail:
singaporesales@power.com

CHINA (SHENZHEN)

17/F, Hivac Building, No. 2, Keji
Nan 8th Road, Nanshan District,
Shenzhen, China, 518057
Phone: +86-755-8672-8689
Fax: +86-755-8672-8690
e-mail: chinasales@power.com

ITALY

Via Milanese 20, 3rd. Fl.
20099 Sesto San Giovanni (MI)
Italy
Phone: +39-024-550-8701
Fax: +39-028-928-6009
e-mail: eurosales@power.com

TAIWAN

5F, No. 318, Nei Hu Rd.,
Sec. 1
Nei Hu District
Taipei 11493, Taiwan R.O.C.
Phone: +886-2-2659-4570
Fax: +886-2-2659-4550
e-mail: taiwansales@power.com

GERMANY

(AC-DC/LED Sales)
Lindwurmstrasse 114
80337, Munich
Germany
Phone: +49-895-527-39110
Fax: +49-895-527-39200
e-mail: eurosales@power.com

JAPAN

Kosei Dai-3 Building
2-12-11, Shin-Yokohama,
Kohoku-ku, Yokohama-shi,
Kanagawa 222-0033
Japan
Phone: +81-45-471-1021
Fax: +81-45-471-3717
e-mail: japansales@power.com

UK

Cambridge Semiconductor,
a Power Integrations company
Westbrook Centre, Block 5, 2nd
Floor
Milton Road
Cambridge CB4 1YG
Phone: +44 (0) 1223-446483
e-mail: eurosales@power.com

**Power Integrations, Inc.**

Tel: +1 408 414 9200 Fax: +1 408 414 9201
www.power.com