



Design Example Report

Title	<i>High Efficiency 18 W Power Supply Using TOP254EN and a Small Transformer Core Size</i>
Specification	90 VAC – 265 VAC Input; 12 V, 1.5 A Output
Application	Adapter
Author	Applications Engineering Department
Document Number	DER-234
Date	September 17, 2009
Revision	1.0

Summary and Features

- Low component count
- Very low no-load input power (<150 mW at 230 VAC)
- High active mode efficiency (81%)
 - Easily meets Energy Star 2.0 efficiency requirement of 80%
 - Easily meets USA Energy Independence and Security Act 2007 requirement of 76%
 - Easily meets EU CoC v4 and EuP Tier 2 requirement of 80%
- Very high efficiency in both standby and sleep modes
- Excellent transient load response
- Hysteretic thermal overload protection with automatic recovery
- Meets limited power source requirements (<100 VA) with single point failure
- Power Integrations eSIP low-profile package
- No potting required to meet thermal specifications
- Meets radiated EMI with >6dB QP margin

PATENT INFORMATION

The products and applications illustrated herein (including transformer construction and circuits external to the products) may be covered by one or more U.S. and foreign patents, or potentially by pending U.S. and foreign patent applications assigned to Power Integrations. A complete list of Power Integrations' patents may be found at www.powerint.com. Power Integrations grants its customers a license under certain patent rights as set forth at <http://www.powerint.com/ip.htm>.

Table of Contents

1	Introduction.....	4
2	Power Supply Specification	5
3	Schematic.....	6
4	Circuit Description	7
4.1	Input EMI Filtering	7
4.2	TOPSwitch Primary	7
4.3	Energy Efficiency.....	7
4.4	Output Power Limiting with Line Voltage.....	7
4.5	Output Rectification and Filtering	7
4.6	Thermal Overload Protection.....	8
5	PCB Layout	9
6	Bill of Materials	10
7	Transformer Specification.....	11
7.1	Electrical Diagram	11
7.2	Electrical Specifications.....	11
7.3	Materials.....	11
7.4	Transformer Build Diagram	12
7.5	Transformer Construction.....	13
8	Transformer Spreadsheets.....	14
9	Mechanical Drawings	19
9.1	TOP254EN (U1) Heatsink	19
10	Performance Data.....	20
10.1	Full Load Efficiency	20
10.2	Active Mode Efficiency	21
10.3	Energy Efficiency Requirements	22
10.3.1	USA Energy Independence and Security Act 2007.....	23
10.3.2	ENERGY STAR EPS Version 2.0	23
10.4	No-load Input Power.....	24
10.5	Available Standby Output Power.....	25
10.6	Regulation	26
10.6.1	Load	26
10.6.2	Line	27
11	Thermal Performance	28
12	Waveforms.....	29
12.1	Drain Voltage and Current, Normal Operation.....	29
12.2	Output Voltage Start-up Profile.....	29
12.3	Drain Voltage and Current Start-up Profile	30
12.4	Load Transient Response (75% to 100% Load Step)	30
12.5	Output Ripple Measurements.....	31
12.5.1	Ripple Measurement Technique	31
12.5.2	Measurement Results	32
13	Control Loop Measurements.....	33
13.1	115 VAC Maximum Load.....	33
13.2	230 VAC Maximum Load.....	33



14 Conducted EMI34
15 Radiated EMI38
16 Revision History40

Important Note:

Although this board is designed to satisfy safety isolation requirements, the engineering prototype has not been agency approved. Therefore, all testing should be performed using an isolation transformer to provide the AC input to the prototype board.



1 Introduction

This document is an engineering report describing an adapter power supply utilizing a TOPSwitch-HX TOP254EN. This power supply is intended as a general purpose evaluation platform that operates from universal input and provides a 12 V, continuous 18 W output. PCB board dimension is 75.75 mm x 37 mm.

The adapter meets Energy Star 2.0 >80% average-efficiency, no-load <150 mW at 230 VAC and meets CISPR conducted and radiated EMI with more than 6dB margin.

This power supply offers thermal overload protection with auto-recovery using large hysteresis.

The document contains the power supply specification, schematic, bill of materials, transformer documentation, printed circuit layout, and performance data. Conducted and radiated EMI results are provided as well.

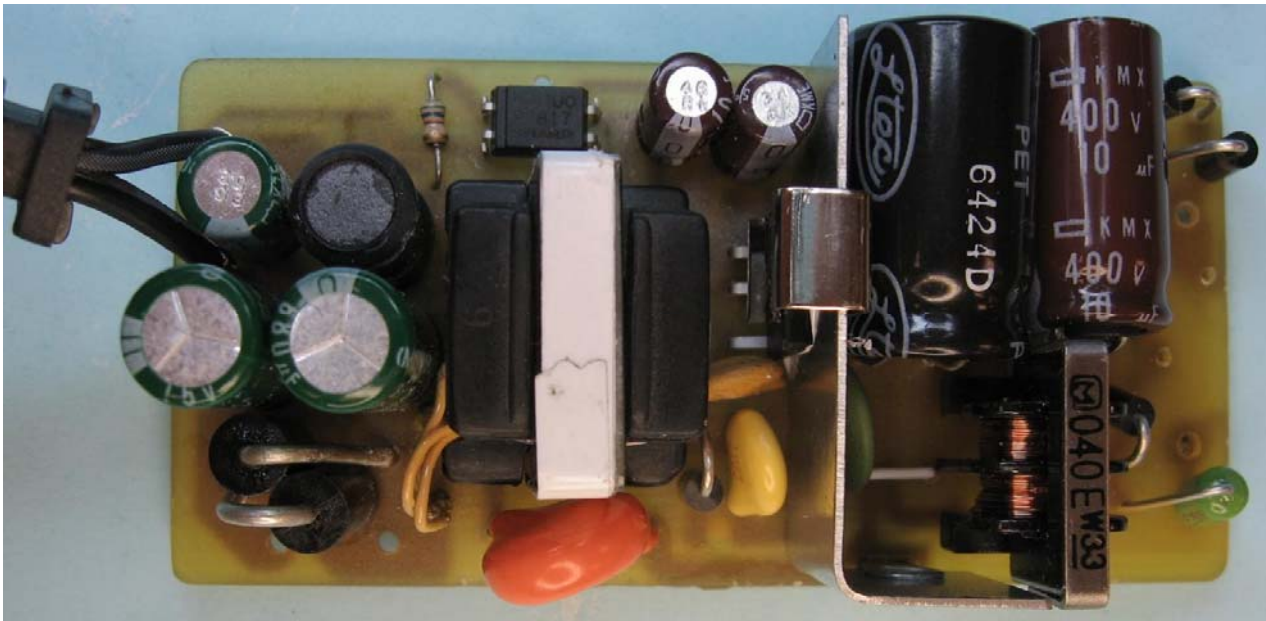

Figure 1 – Populated Circuit Board Photograph.



2 Power Supply Specification

The table below represents the minimum acceptable performance of the design. Actual performance is listed in the results section.

Description	Symbol	Min	Typ	Max	Units	Comment
Input						
Voltage	V_{IN}	90		265	VAC	2 Wire – no P.E.
Frequency	f_{LINE}	47	50/60	64	Hz	
No-load Input Power (230 VAC)				0.15	W	
Output						
Output Voltage 1	V_{OUT1}		12		V	± 5% 20 MHz bandwidth
Output Ripple Voltage 1	$V_{RIPPLE1}$			120	mV	
Output Current 1	I_{OUT1}			1.5	A	
Total Output Power						
Continuous Output Power	P_{OUT}			18	W	
Efficiency						
Full Load	η	80			%	Measured at P_{OUT} 25 °C
Required average efficiency at 25, 50, 75 and 100 % of P_{OUT}	$\eta_{ES2.0}$	80			%	Per ENERGY STAR V2.0
Environmental						
Conducted EMI			Meets CISPR22B / EN55022B			
Safety			Designed to meet IEC950 / UL1950 Class II			
Line Surge						1.2/50 μ s surge, IEC 1000-4-5, Series Impedance: Differential Mode: 2 Ω Common Mode: 12 Ω
Differential Mode (L1-L2)				1	kV	
Common mode (L1/L2-PE)				2	kV	
Ambient Temperature	T_{AMB}	0	25	40	°C	Free convection, sea level



3 Schematic

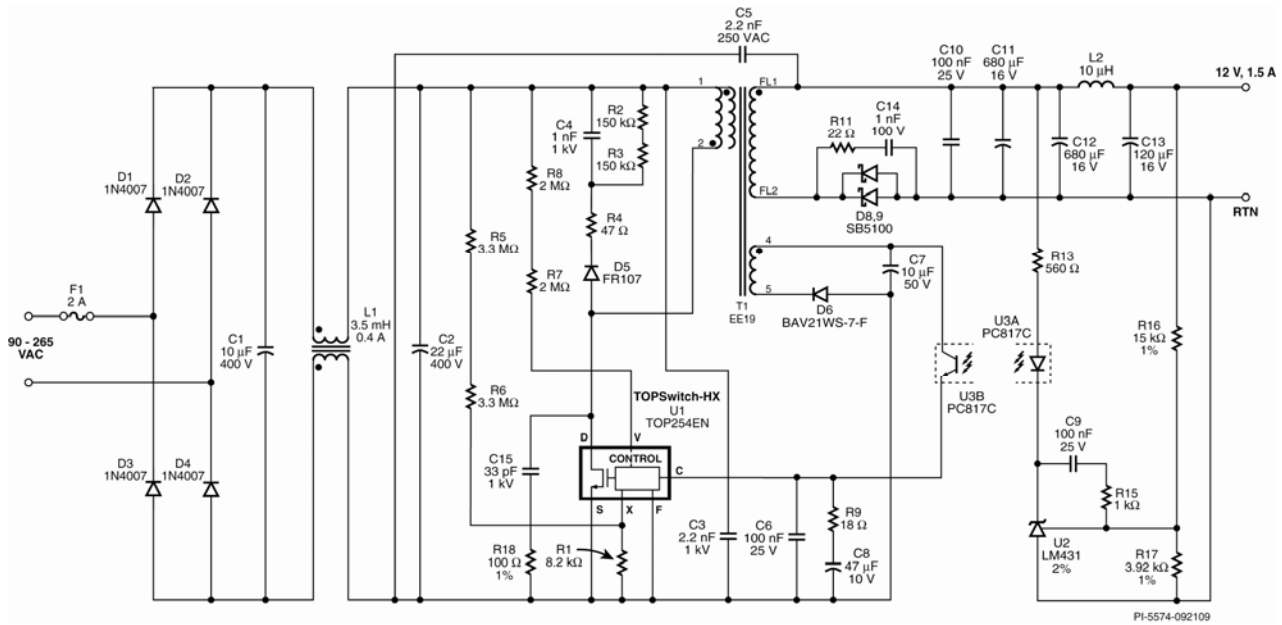

Note: L2, C11 and C12 can be further reduced depending on ripple requirement

Figure 2 – Schematic.



4 Circuit Description

This design centers around the TOP254EN in a flyback topology for a low no-load, high efficiency and compact power supply operating from universal input and providing a 12 V, 18 W output.

4.1 Input EMI Filtering

Fuse F1 provides catastrophic fault protection to the circuit, and isolates it from the AC source. Diodes D1 through D4 rectify the AC input. Capacitor C1 and C2 filters the resulting DC. Bulk capacitor C1 also reduces differential-mode noise EMI. A common mode inductor L1 filters common-mode EMI. This input filter eliminates additional X class capacitors and associated discharge resistors, minimizing no-load input power.

4.2 TOPSwitch Primary

This adapter power supply employs the TOPSwitch TOP254EN (U1), which integrates a high voltage MOSFET and PWM controller.

132 kHz operation was chosen to minimize transformer size and allowed the use of an EE19 core size vs. the EE22 core size that is required for 66 kHz operation. This high frequency operation has no impact on efficiency or EMI thanks to PI MOSFET technology and proprietary frequency jitter feature.

The TOP254EN regulates the output by adjusting the duty cycle based on the current into its CONTROL (C) pin. The power supply output voltage is sensed on the secondary side by shunt regulator U2 and provides a feedback signal to the primary side through optocoupler U3.

4.3 Energy Efficiency

The EcoSmart[®] feature of U1 provides constant efficiency over the entire load range. The proprietary Multi-cycle Modulation function automatically achieves this performance, eliminating special operating modes triggered at specific loads, which greatly simplifies circuit design.

4.4 Output Power Limiting with Line Voltage

To provide constant output power with varying line voltage, R1, R5, and R6 reduce the internal current limit of U1 as the line voltage increases. This allows the supply to limit the output power to <100 VA (limited power source safety requirement) at high line and deliver the rated output at low line.

4.5 Output Rectification and Filtering

Dual 5 A 100 V Schottky diodes were used for low cost and high efficiency. The 100 V rating provides >20% voltage stress de-rating. Output filtering is provided by C11 and C12. A snubber network on the output formed by R11 and C14 attenuates high-frequency ringing for reduced EMI. These two components were chosen with smaller values to allow high-frequency ringing to be damped while keeping any power dissipation they



cause at no-load to a minimum. Inductor L2 and capacitor C13 form an output second stage filter to reduce switching frequency ripple and noise.

Capacitor C10 was added to shrink the loop area formed by the secondary winding output diode and output capacitors. This improved both conducted and radiated EMI. The values of C11, C12, L2 and C13 may be adjusted depending on the specific output ripple specification.

4.6 Thermal Overload Protection

IC U1 has an integrated, 100% tested, accurate hysteretic thermal-overload protection feature. If the junction temperature reaches +142 °C (during a fault condition), U1 shuts down. It automatically recovers once the junction temperature has decreased by approximately 75 °C.



5 PCB Layout

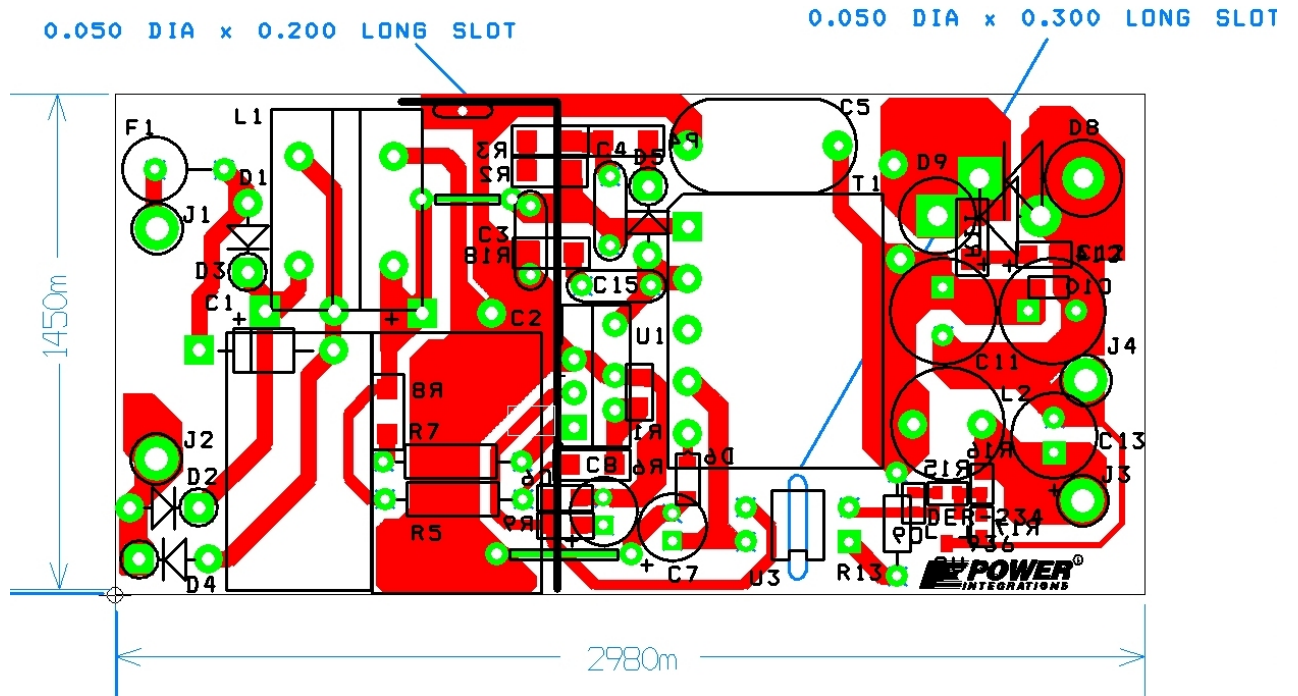

Figure 3 – Printed Circuit Layout (1450 mils x 2980 mils).



6 Bill of Materials

Item	Qty	Ref Des	Description	Mfg Part Number	Manufacturer
1	1	C1	10 μ F, 400 V, Electrolytic, Low ESR, 2.9 Ω , (10 x 20)	EKMX401ELL100MJ20S	Nippon Chemi-Con
2	1	C2	22 μ F, 400 V, Electrolytic, High Ripple, (12.5 x 18)	Not Provided	Samxon
3	1	C3	2.2 nF, 1 kV, Disc Ceramic	NCD222K1KVY5FF	NIC Components Corp
4	1	C4	0.001 μ F, 1 kV, Disc Ceramic	562R10TSD10	Vishay
5	1	C5	2.2 nF, 250 VAC, Film, X1Y1	CD12-E2GA222MYNS	TDK
6	1	C6	100 nF, 25 V, Ceramic, X7R, 0805	ECJ-2VB1E104K	Panasonic
7	1	C7	10 μ F, 50 V, Electrolytic, Gen. Purpose, (5 x 11)	KME50VB10RM5X11LL	Nippon Chemi-Con
8	1	C8	47 μ F, 10 V, Electrolytic, Gen. Purpose, (5 x 11)	KME10VB22RM5X11LL	Nippon Chemi-Con
9	2	C9 C10	100 nF 25 V, Ceramic, X7R, 0603	ECJ-1VB1E104K	Panasonic
10	2	C11 C12	680 μ F, 16 V, Electrolytic, Very Low ESR, 38 m Ω , (8 x 20)	EKZE160ELL681MH20D	Nippon Chemi-Con
11	1	C13	120 μ F, 16 V, Electrolytic, Very Low ESR, 130 m Ω , (6.3 x 11)	EKZE160ELL121MF11D	Nippon Chemi-Con
12	1	C14	1 nF, 100 V, Ceramic, X7R, 0805	ECJ-2VB2A102K	Panasonic
13	1	C15	33 pF, 1 kV, Disc Ceramic	ECC-A3A330JGE	Panasonic
14	4	D1 D2 D3 D4	1000 V, 1 A, Rectifier, DO-41	1N4007-E3/54	Vishay
15	1	D5	1000 V, 1 A, Fast Recovery Diode, DO-41	FR107-T-F	Diodes Inc.
16	1	D6	250 V, 0.2 A, Fast Switching, 50 ns, SOD-323	BAV21WS-7-F	Diode Inc.
17	2	D8 D9	100 V, 5 A, Schottky, DO-201AD1	SB5100	Fairchild
18	1	F1	2 A, 250 V, Slow, 5 mm x 20 mm, Axial	230002	Littelfuse
21	1	L1	3.5 mH, 0.4A	ELF-11M040E	
22	1	L2	10 μ H, 3.0 A	R622LY-100K	Toko
23	1	R1	8.2 k Ω , 5%, 1/8 W, Metal Film, 0805	ERJ-6GEYJ822V	Panasonic
24	2	R2 R3	150 k Ω , 5%, 1/4 W, Metal Film, 1206	ERJ-8GEYJ154V	Panasonic
25	1	R4	47 Ω , 5%, 1/4 W, Metal Film, 1206	ERJ-8GEYJ470V	Panasonic
26	2	R5 R6	3.3 M Ω , 5%, 1/4 W, Metal Film, 1206	ERJ-8GEYJ335V	Panasonic
27	2	R7 R8	2 M Ω , 5%, 1/4 W, Metal Film, 1206	ERJ-8GEYJ205V	Panasonic
28	1	R9	18 Ω , 5%, 1/8 W, Metal Film, 0805	ERJ-6GEYJ180V	Panasonic
29	1	R11	22 Ω , 5%, 1/4 W, Metal Film, 1206	ERJ-8GEYJ220V	Panasonic
30	1	R13	560 Ω , 5%, 1/10 W, Metal Film, 0603	ERJ-3GEYJ561V	Panasonic
31	1	R15	1 k Ω , 5%, 1/10 W, Metal Film, 0603	ERJ-3GEYJ102V	Panasonic
32	1	R16	15 k Ω , 1%, 1/16 W, Metal Film, 0603	ERJ-3EKF1502V	Panasonic
33	1	R17	3.92 k Ω , 1%, 1/16 W, Metal Film, 0603	ERJ-3EKF3921V	Panasonic
34	1	R18	100 Ω , 1%, 1/4 W, Metal Film, 1206	ERJ-8ENF1000V	Panasonic
35	1	T1	Bobbin, EE19, Vertical, 10 pins	YC-1902	Ying Chin
36	1	U1	TOPSwitch-HX, TOP254EN, eSIP-7C	TOP254EN	Power Integrations
37	1	U2	IC, REG ZENER SHUNT ADJ SOT-23	LM431AIM3/NOPB	National Semiconductor
38	1	U3	Opto coupler, 35 V, CTR 200-300%, 4-DIP	PC817C	Sharp



7 Transformer Specification

7.1 Electrical Diagram

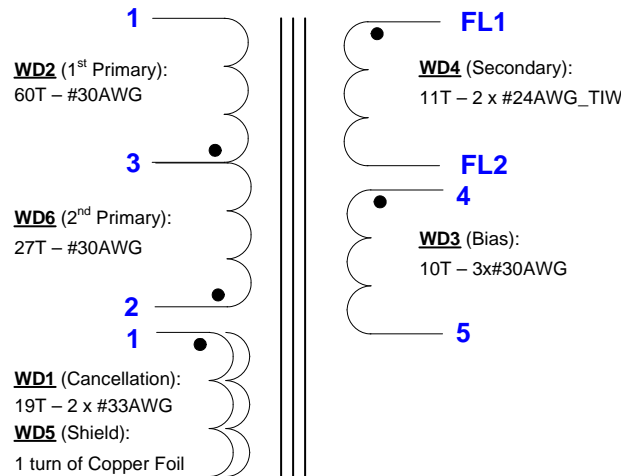

Figure 4 – Transformer Electrical Diagram.

7.2 Electrical Specifications

Electrical Strength	1 second, 60 Hz, from pins 1-5 to pins FL1–FL2	3000 VAC
Primary Inductance	Pins 1-2, all other windings open, measured at 132 kHz, 0.4 VRMS	792 μ H, \pm 10%
Resonant Frequency	Pins 1-2, all other windings open	800 kHz (Min.)
Primary Leakage Inductance	Pins 1-2, with pins FL1–FL2 shorted, measured at 132 kHz, 0.4 VRMS	24 μ H (Max.)

7.3 Materials

Item	Description
[1]	Core: EE19, ACME: P4EE19. Gapped for AL of 86 nH/T ² .
[2]	Bobbin: BEE19, vertical, 10 pins (5/5), (Note: pins 6-10 removed).
[3]	Magnet wire: #33 AWG (double coated).
[4]	Magnet wire: #30 AWG (double coated).
[5]	Magnet wire: #34 AWG (double coated).
[6]	Magnet wire: #24 AWG – Triple Insulated Wire.
[7]	Copper foil tape: 2 mils thick, 8.5 mm wide, to be attached with tape item [8]. (See Figure 6).
[8]	Tape: 3M 1298 polyester film, 9.0 mm wide.



7.4 Transformer Build Diagram

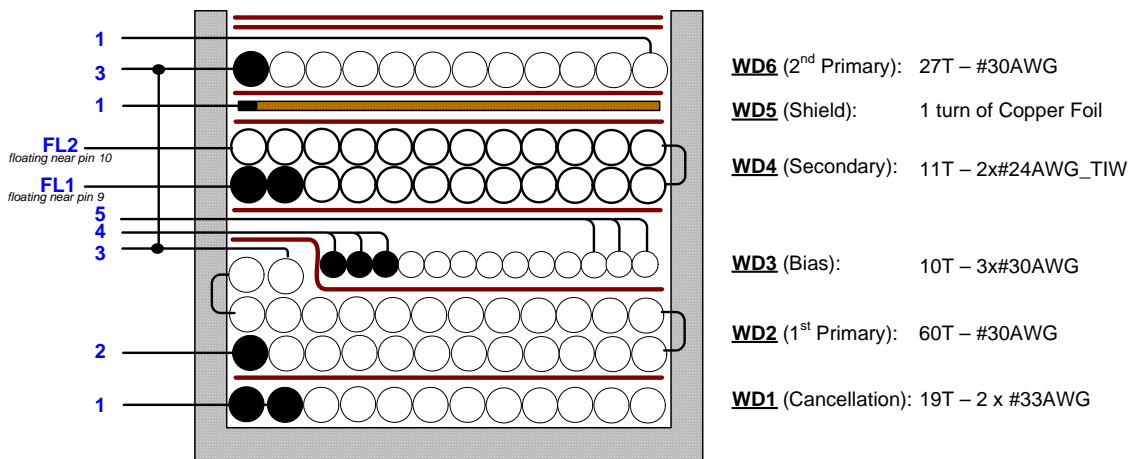

Figure 5 – Transformer Build Diagram.

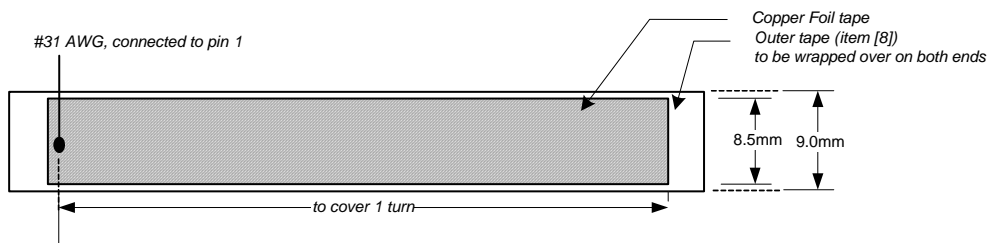

Figure 6 – Copper foil Tape.



7.5 Transformer Construction

Bobbin Preparation	Position the bobbin on the mandrel so pin side on the left hand side. Winding direction is clockwise direction.
WD1 Cancellation	Start at pin 1, wind 19 bifilar turns of item [3], from right to left, spread the wires evenly. At the last turn cut the end and leave no-connect.
Insulation	1 layer of tape item [8].
WD2 1st Primary	Start at pin 2, wind 29 turns of item [4], from right to left for the first layer, then from left to right also about 29 turns for second layer, and wind 2 turns for third layer close to the left side of bobbin and terminate at pin 3. (Total for this winding is 60 turns).
Insulation	1 layer of tape item [8].
WD3 Bias	Start at pin 4, on the same layer (third layer of last winding), wind 10 trifilar turns of item [5] from right to left, spread the wires evenly on the bobbin, and bring the wires back to the left to terminate at pin 5.
Insulation	1 layer of tape item [8].
WD4 Secondary	Leave start end about 1 inch at pin 9 position for FL1, wind 11 bifilar turns of item [6] from right to left and then from left to right in 2 layers. Also leave the wires about 1 inch on pin 10 position for FL2. Do not terminate the wires.
Insulation	1 layer of tape item [8].
WD5 Shield	Apply item [7] for 1 turn and should be overlapped.
WD6 2nd Primary	Start at pin 3, wind 27 turns of item [4] in one layer, from right to left. At the last turn, bring the wire back to the left and terminate at pin 1.
Insulation	2 layer of tape item [8].
Finish	Grind cores to get an inductance of 792 μ H. Assemble and secure the cores with tape. Varnish.



8 Transformer Spreadsheets

ACDC_TOPSwitchHX_100208; Rev.1.10; Copyright Power Integrations 2008	INPUT	INFO	OUTPUT	UNIT	TOP_HX_100208: TOPSwitch-HX Continuous/Discontinuous Flyback Transformer Design Spreadsheet
ENTER APPLICATION VARIABLES					
VACMIN	90			Volts	Minimum AC Input Voltage
VACMAX	265			Volts	Maximum AC Input Voltage
fL	50			Hertz	AC Mains Frequency
VO	12			Volts	Output Voltage (main)
PO_AVG	18			Watts	Average Output Power
PO_PEAK			18.00	Watts	Peak Output Power
N	0.81			%/100	Efficiency Estimate
Z	0.5				Loss Allocation Factor
VB	10	Info		Volts	Ensure proper operation at no load.
tC	3			mSeconds	Bridge Rectifier Conduction Time Estimate
CIN	33		33	uFarads	Input Filter Capacitor
ENTER TOPSWITCH-HX VARIABLES					
TOPSwitch-HX	TOP254EN			Universal / Peak	115 Doubled/230V
Chosen Device		TOP254EN	Power Out	43 W / 43 W	62W
KI	0.75				External Ilimit reduction factor (KI=1.0 for default ILIMIT, KI <1.0 for lower ILIMIT)
ILIMITMIN_EXT			0.907	Amps	Use 1% resistor in setting external ILIMIT
ILIMITMAX_EXT			1.043	Amps	Use 1% resistor in setting external ILIMIT
Frequency (F)=132kHz, (H)=66kHz	f		f		Select 'H' for Half frequency - 66kHz, or 'F' for Full frequency - 132kHz
fS			132000	Hertz	TOPSwitch-HX Switching Frequency: Choose between 132 kHz and 66 kHz
fSmin			119000	Hertz	TOPSwitch-HX Minimum Switching Frequency
fSmax			145000	Hertz	TOPSwitch-HX Maximum Switching Frequency
High Line Operating Mode			FF		Full Frequency, Jitter enabled
VOR	109			Volts	Reflected Output Voltage
VDS			10	Volts	TOPSwitch on-state Drain to Source Voltage
VD	0.5			Volts	Output Winding Diode Forward Voltage Drop
VDB	0.7			Volts	Bias Winding Diode Forward Voltage Drop
KP	0.67				Ripple to Peak Current Ratio (0.3 < KRP < 1.0 : 1.0 < KDP < 6.0)
PROTECTION FEATURES					
LINE SENSING					
VUV_STARTUP			101	Volts	Minimum DC Bus Voltage at which the power supply will start-up



VOV_SHUTDOWN			490	Volts	Typical DC Bus Voltage at which power supply will shut-down (Max)
RLS			4.4	M-ohms	Use two standard 2.2 M Ω , 5% resistors in series for line sense functionality.
OUTPUT OVERVOLTAGE					
VZ			0	Volts	Zener Diode rated voltage for Output Overvoltage shutdown protection
RZ			5.1	k-ohms	Output OVP resistor. For latching shutdown use 20 ohm resistor instead
OVERLOAD POWER LIMITING					
Overload Current Ratio at VMAX			1.2		Enter the desired margin to current limit at VMAX. A value of 1.2 indicates that the current limit should be 20% higher than peak primary current at VMAX
Overload Current Ratio at VMIN			1.27		Margin to current limit at low line.
ILIMIT_EXT_VMIN			0.68	A	Peak primary Current at VMIN
ILIMIT_EXT_VMAX			0.66	A	Peak Primary Current at VMAX
RIL			8.39	k-ohms	Current limit/Power Limiting resistor.
RPL			N/A	M-ohms	Resistor not required. Use RIL resistor only
ENTER TRANSFORMER CORE/CONSTRUCTION VARIABLES					
Core Type	ee19		ee19		Core Type
Core		EE19		P/N:	PC40EE19-Z
Bobbin		EE19_BOBBIN		P/N:	BE-19-118CPH
AE			0.23	cm ²	Core Effective Cross Sectional Area
LE			3.94	cm	Core Effective Path Length
AL			1250	nH/T ²	Ungapped Core Effective Inductance
BW			9	mm	Bobbin Physical Winding Width
M	0			mm	Safety Margin Width (Half the Primary to Secondary Creepage Distance)
L	3				Number of Primary Layers
NS	11		11		Number of Secondary Turns
DC INPUT VOLTAGE PARAMETERS					
VMIN			82	Volts	Minimum DC Input Voltage
VMAX			375	Volts	Maximum DC Input Voltage
CURRENT WAVEFORM SHAPE PARAMETERS					
DMAX			0.60		Maximum Duty Cycle (calculated at PO_PEAK)
I AVG			0.27	Amps	Average Primary Current (calculated at average output power)
IP			0.68	Amps	Peak Primary Current (calculated at Peak output power)
IR			0.45	Amps	Primary Ripple Current (calculated at average output)



					power)
IRMS			0.36	Amps	Primary RMS Current (calculated at average output power)
TRANSFORMER PRIMARY DESIGN PARAMETERS					
LP			792	uHenries	Primary Inductance
LP Tolerance	10		10		Tolerance of Primary Inductance
NP			96		Primary Winding Number of Turns
NB			9		Bias Winding Number of Turns
ALG			86	nH/T^2	Gapped Core Effective Inductance
BM			2426	Gauss	Maximum Flux Density at PO, VMIN (BM<3000)
BP			4122	Gauss	Peak Flux Density (BP<4200) at ILIMITMAX and LP_MAX. Note: Recommended values for adapters and external power supplies <=3600 Gauss
BAC			813	Gauss	AC Flux Density for Core Loss Curves (0.5 X Peak to Peak)
ur			1704		Relative Permeability of Ungapped Core
LG			0.31	mm	Gap Length (Lg > 0.1 mm)
BWE			27	mm	Effective Bobbin Width
OD			0.28	mm	Maximum Primary Wire Diameter including insulation
INS			0.05	mm	Estimated Total Insulation Thickness (= 2 * film thickness)
DIA			0.23	mm	Bare conductor diameter
AWG			31	AWG	Primary Wire Gauge (Rounded to next smaller standard AWG value)
CM			81	Cmils	Bare conductor effective area in circular mils
CMA			222	Cmils/Amp	Primary Winding Current Capacity (200 < CMA < 500)
Primary Current Density (J)			9.04	Amps/mm^2	Primary Winding Current density (3.8 < J < 9.75)
TRANSFORMER SECONDARY DESIGN PARAMETERS (SINGLE OUTPUT EQUIVALENT)					
Lumped parameters					
ISP			5.89	Amps	Peak Secondary Current
ISRMS			2.58	Amps	Secondary RMS Current
IO_PEAK			1.50	Amps	Secondary Peak Output Current
IO			1.50	Amps	Average Power Supply Output Current
IRIPPLE			2.09	Amps	Output Capacitor RMS Ripple Current
CMS			515	Cmils	Secondary Bare Conductor minimum circular mils
AWGS			22	AWG	Secondary Wire Gauge (Rounded up to next larger standard AWG value)
DIAS			0.65	mm	Secondary Minimum Bare Conductor Diameter
ODS			0.82	mm	Secondary Maximum Outside Diameter for Triple Insulated Wire
INSS			0.09	mm	Maximum Secondary Insulation Wall Thickness
VOLTAGE STRESS PARAMETERS					
VDRAIN			591	Volts	Maximum Drain Voltage Estimate



					(Includes Effect of Leakage Inductance)
PIVS			55	Volts	Output Rectifier Maximum Peak Inverse Voltage
PIVB			47	Volts	Bias Rectifier Maximum Peak Inverse Voltage
TRANSFORMER SECONDARY DESIGN PARAMETERS (MULTIPLE OUTPUTS)					
1st output					
VO1			12	Volts	Output Voltage
IO1_AVG			1.50	Amps	Average DC Output Current
PO1_AVG			18.00	Watts	Average Output Power
VD1			0.5	Volts	Output Diode Forward Voltage Drop
NS1			11.00		Output Winding Number of Turns
ISRMS1			2.576	Amps	Output Winding RMS Current
IRIPPLE1			2.09	Amps	Output Capacitor RMS Ripple Current
PIVS1			55	Volts	Output Rectifier Maximum Peak Inverse Voltage
CMS1			515	Cmils	Output Winding Bare Conductor minimum circular mils
AWGS1			22	AWG	Wire Gauge (Rounded up to next larger standard AWG value)
DIAS1			0.65	mm	Minimum Bare Conductor Diameter
ODS1			0.82	mm	Maximum Outside Diameter for Triple Insulated Wire
2nd output					
VO2				Volts	Output Voltage
IO2_AVG				Amps	Average DC Output Current
PO2_AVG			0.00	Watts	Average Output Power
VD2			0.7	Volts	Output Diode Forward Voltage Drop
NS2			0.62		Output Winding Number of Turns
ISRMS2			0.000	Amps	Output Winding RMS Current
IRIPPLE2			0.00	Amps	Output Capacitor RMS Ripple Current
PIVS2			2	Volts	Output Rectifier Maximum Peak Inverse Voltage
CMS2			0	Cmils	Output Winding Bare Conductor minimum circular mils
AWGS2			N/A	AWG	Wire Gauge (Rounded up to next larger standard AWG value)
DIAS2			N/A	mm	Minimum Bare Conductor Diameter
ODS2			N/A	mm	Maximum Outside Diameter for Triple Insulated Wire
3rd output					
VO3				Volts	Output Voltage
IO3_AVG				Amps	Average DC Output Current
PO3_AVG			0.00	Watts	Average Output Power
VD3			0.7	Volts	Output Diode Forward Voltage Drop
NS3			0.62		Output Winding Number of Turns
ISRMS3			0.000	Amps	Output Winding RMS Current
IRIPPLE3			0.00	Amps	Output Capacitor RMS Ripple Current
PIVS3			3	Volts	Output Rectifier Maximum Peak

					Inverse Voltage
CMS3			0	Cmils	Output Winding Bare Conductor minimum circular mils
AWGS3			N/A	AWG	Wire Gauge (Rounded up to next larger standard AWG value)
DIAS3			N/A	mm	Minimum Bare Conductor Diameter
ODS3			N/A	mm	Maximum Outside Diameter for Triple Insulated Wire
Total Continuous Output Power			18	Watts	Total Continuous Output Power
Negative Output			N/A		If negative output exists enter Output number; eg: If VO2 is negative output, enter 2



9 Mechanical Drawings

The following mechanical drawings are for the custom mechanical designs used in this power supply.

9.1 TOP254EN (U1) Heatsink

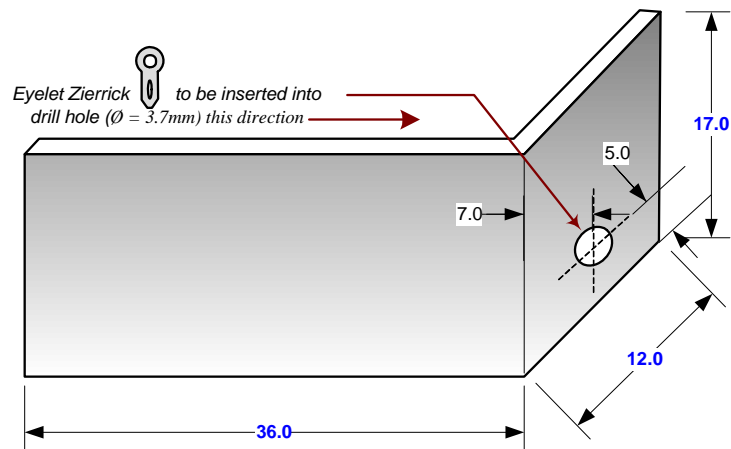
**Note:**

- Unit measurement: mm.
- Thickness: 0.67mm.
- Material: Zinc Plated Steel

Figure 7 – U1 Heatsink.



10 Performance Data

All tests were performed at room temperature with 90 V / 50 Hz, 115 V / 60 Hz, 230 V / 50 Hz, and 265 V / 50 Hz line-input voltages and corresponding frequencies unless otherwise noted. The power supply was put in a plastic case and allowed to warm up for 30 minutes at full load. The input was provided via a 1 meter AC cable. The output was measured at the end of a 1.8 meters #22 AWG cable.

10.1 Full Load Efficiency

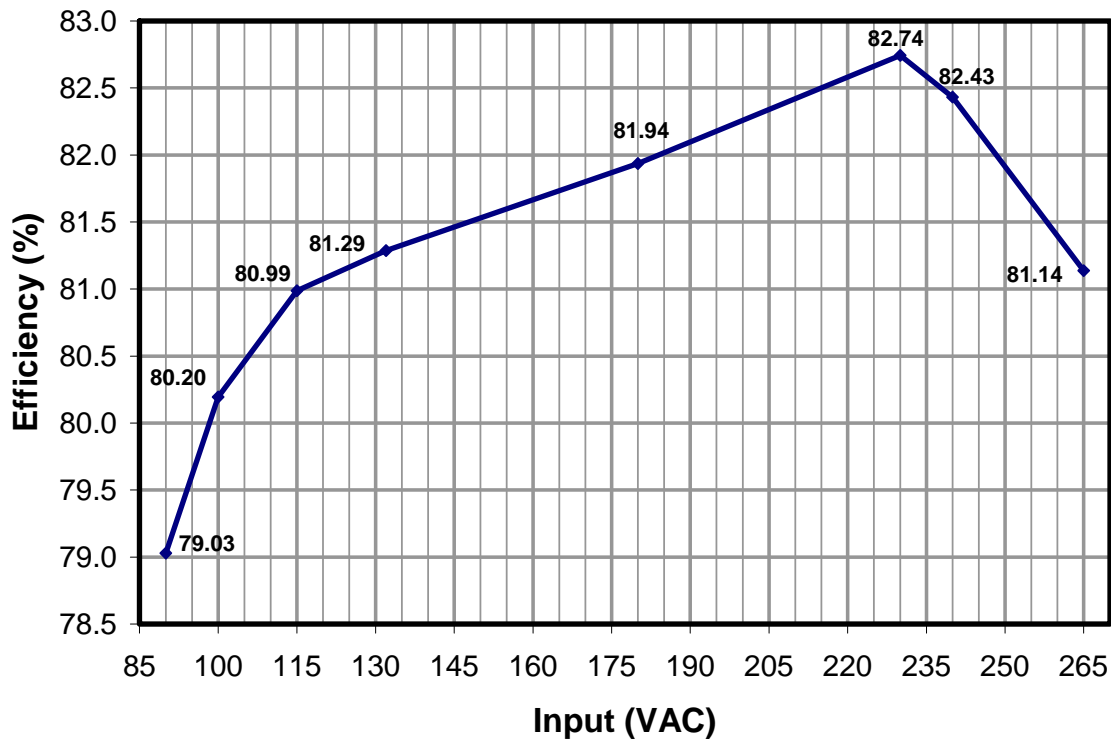

Figure 8 – Efficiency vs. Input Voltage, Room Temperature, 60 Hz.



10.2 Active Mode Efficiency

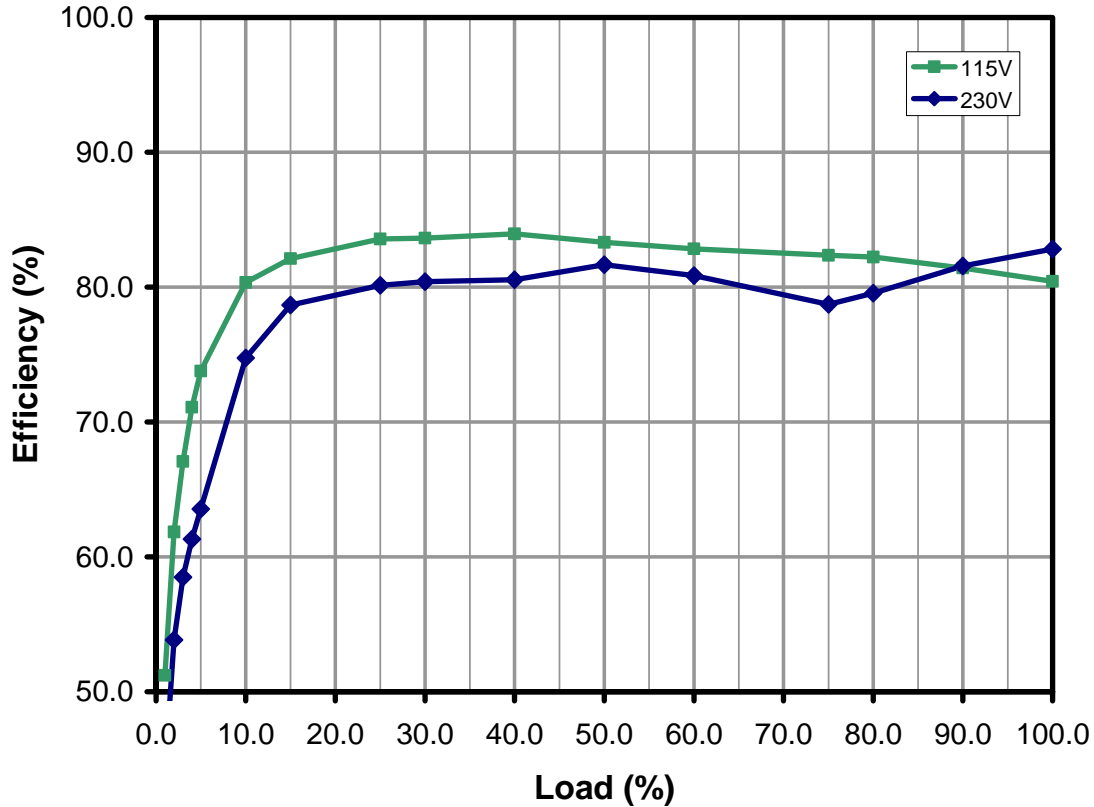

Figure 9 – Efficiency vs. Load.

Percent of Full Load	Efficiency (%)	
	115 VAC	230 VAC
25	83.57	80.13
50	83.33	81.66
75	82.36	78.72
100	80.43	82.82
Average	82.42	80.83
US EISA (2007) requirement	76	
ENERGY STAR EPS v2, EC CoC v4, EUP Tier 2	80	



10.3 Energy Efficiency Requirements

The external power supply requirements below all require meeting active mode efficiency and no-load input power limits. Minimum active mode efficiency is defined as the average efficiency of 25, 50, 75 and 100% of output current (based on the nameplate output current rating).

For adapters that are single input voltage only then the measurement is made at the rated single nominal input voltage (115 VAC or 230 VAC), for universal input adapters the measurement is made at both nominal input voltages (115 VAC and 230 VAC).

To meet the standard the measured average efficiency (or efficiencies for universal input supplies) must be greater than or equal to the efficiency specified by the standard.

The test method can be found here:

http://www.energystar.gov/ia/partners/prod_development/downloads/power_supplies/EP_SupplyEffic_TestMethod_0804.pdf

For the latest up to date information please visit the PI Green Room:

<http://www.powerint.com/greenroom/regulations.htm>



10.3.1 USA Energy Independence and Security Act 2007

This legislation mandates all single output single output adapters, including those provided with products, manufactured on or after July 1st, 2008 must meet minimum active mode efficiency and no load input power limits.

Active Mode Efficiency Standard Models

Nameplate Output (P_o)	Minimum Efficiency in Active Mode of Operation
< 1 W	$0.5 \times P_o$
≥ 1 W to ≤ 51 W	$0.09 \times \ln(P_o) + 0.5$
> 51 W	0.85

Ln = natural logarithm

No-load Energy Consumption

Nameplate Output (P_o)	Maximum Power for No-load AC-DC EPS
All	≤ 0.5 W

This requirement supersedes the legislation from individual US States (for example CEC in California).

10.3.2 ENERGY STAR EPS Version 2.0

This specification takes effect on November 1st, 2008.

Active Mode Efficiency Standard Models

Nameplate Output (P_o)	Minimum Efficiency in Active Mode of Operation
≤ 1 W	$0.48 \times P_o + 0.14$
> 1 W to ≤ 49 W	$0.0626 \times \ln(P_o) + 0.622$
> 49 W	0.87

ln = natural logarithm

Active Mode Efficiency Low Voltage Models ($V_o < 6$ V and $I_o \geq 550$ mA)

Nameplate Output (P_o)	Minimum Efficiency in Active Mode of Operation
≤ 1 W	$0.497 \times P_o + 0.067$
> 1 W to ≤ 49 W	$0.075 \times \ln(P_o) + 0.561$
> 49 W	0.86

ln = natural logarithm

No-load Energy Consumption (both models)

Nameplate Output (P_o)	Maximum Power for No-load AC-DC EPS
0 to < 50 W	≤ 0.3 W
≥ 50 W to ≤ 250 W	≤ 0.5 W



10.4 No-load Input Power

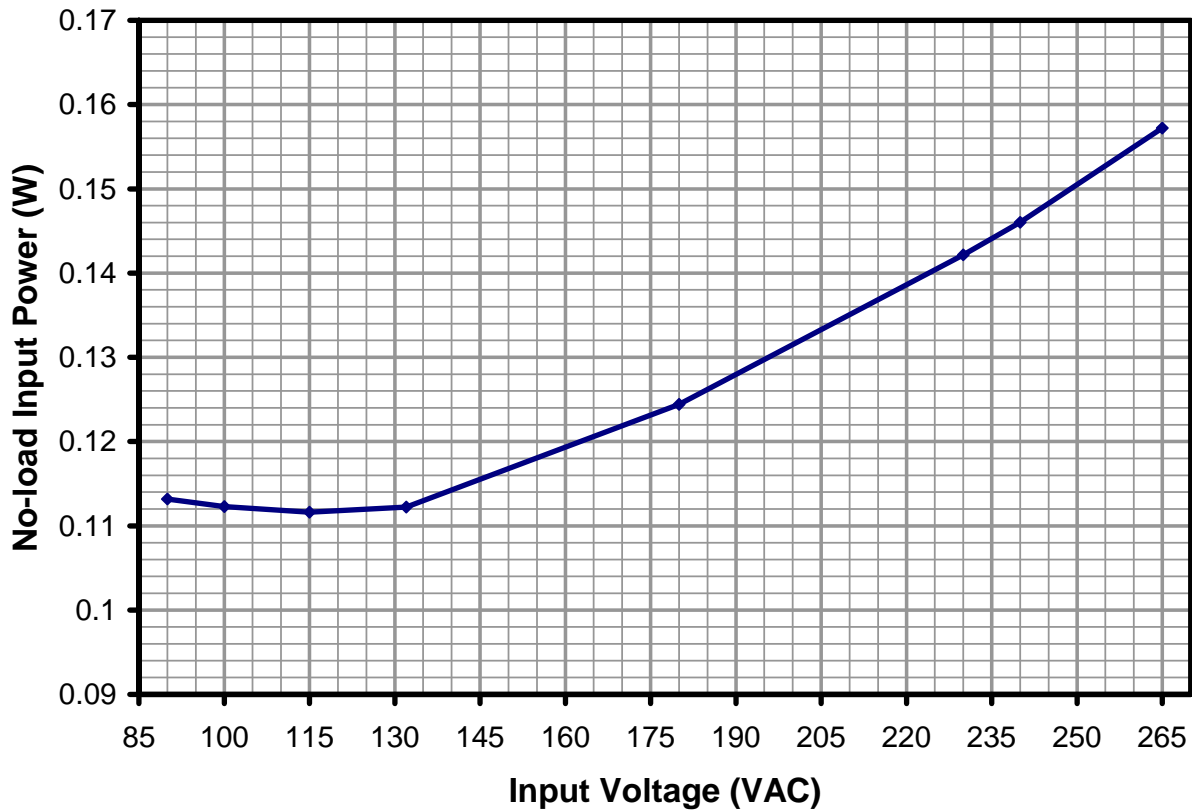

Figure 10 – Zero Load Input Power vs. Input Line Voltage, Room Temperature.



10.5 Available Standby Output Power

The chart below shows the available output power vs line voltage for an input power of 1 W, 2 W and 3 W.

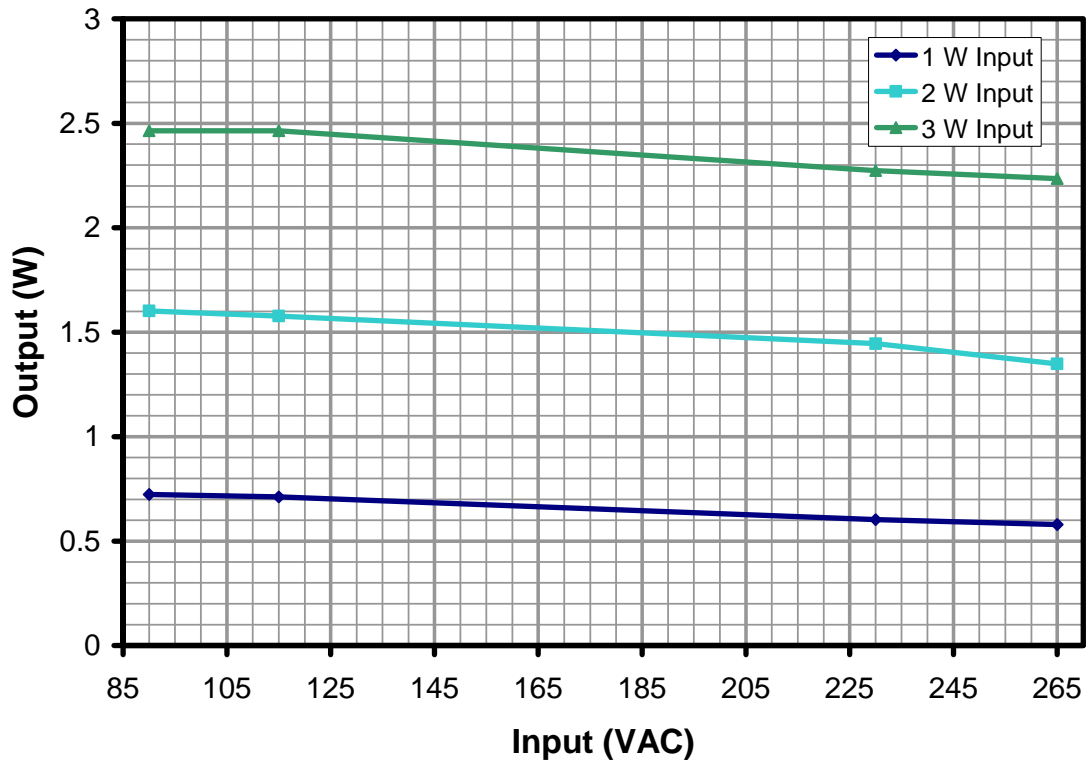

Figure 11 – Available Standby Output Power vs. Input Line Voltage, Room Temperature.



10.6 Regulation

10.6.1 Load

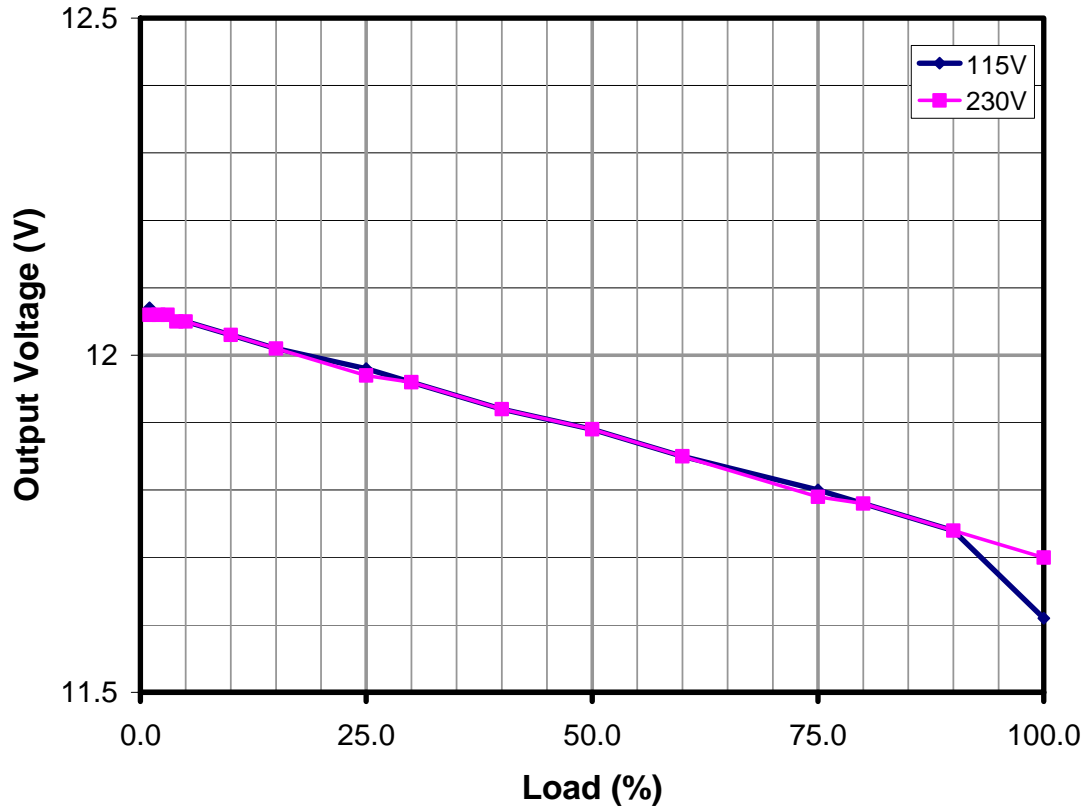

Figure 12 – Load Regulation, Room Temperature.

Note: Reduction in output voltage with load is due to resistive drop in output cable.



10.6.2 Line

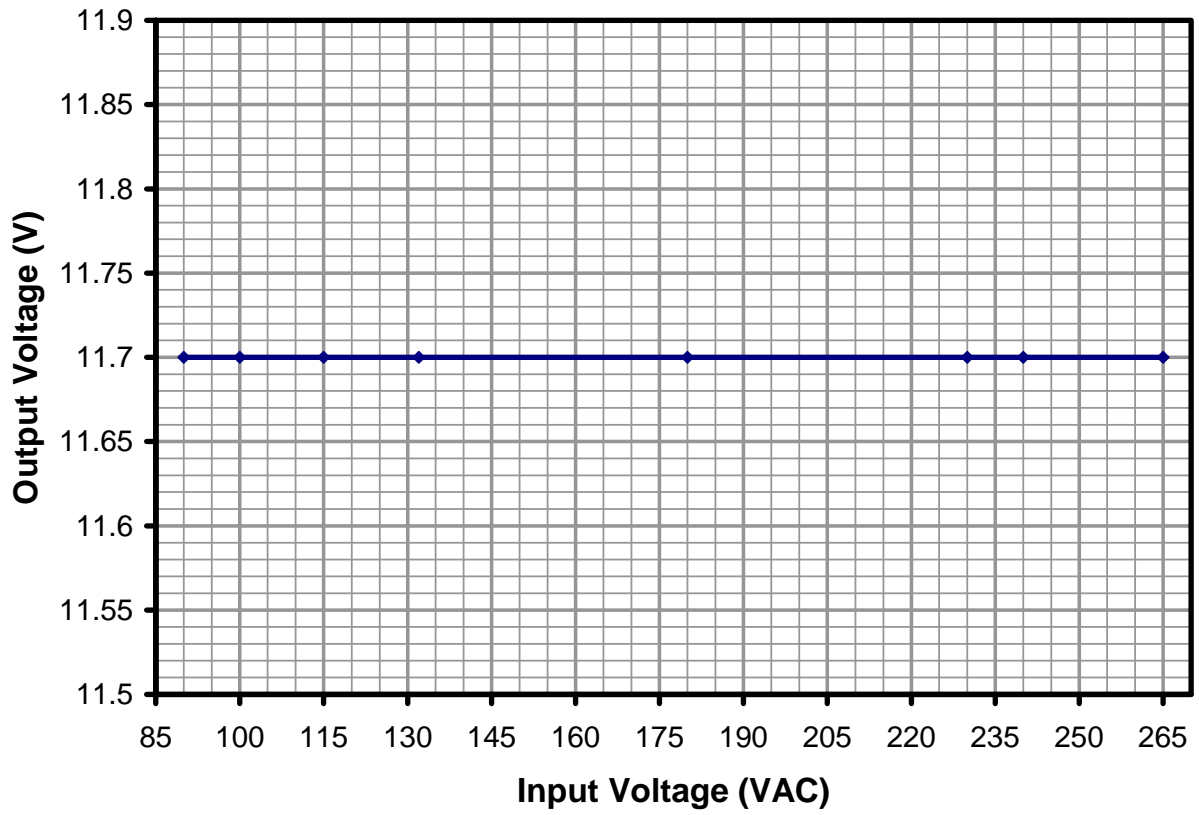

Figure 13 – Line Regulation, Room Temperature, Full Load.



11 Thermal Performance

The power supply was placed inside a plastic case and sealed, without potting material. The supply was heated, with no airflow, for at least two hours and measurements were taken immediately.

The power supply went through a burn-in cycle, which involved running it inside an oven for 12 hours in a 40 °C ambient temperature condition at maximum load. The unit did not at any time go into thermal shutdown.

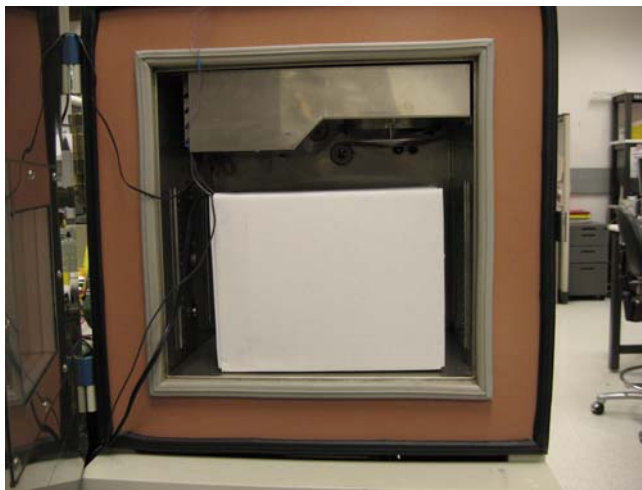

Figure 14 – Carton Box, with Power Supply Adapter Inside, Placed in Oven for Burn-in.

Item	Temperature (°C)			
	90 VAC	115 VAC	230 VAC	265 VAC
Ambient	40.3	39.78	40.3	39.9
TRF winding	110	102	102	106
TRF core	104	97	97	102
Output Rectifier Body	108	105	105	108
Bridge	81	70	59	60
TOP254 (SOURCE pin)	120	104	90	101
CMC	104	88	70	73
Internal ambient	70	66	66	68



12 Waveforms

12.1 Drain Voltage and Current, Normal Operation

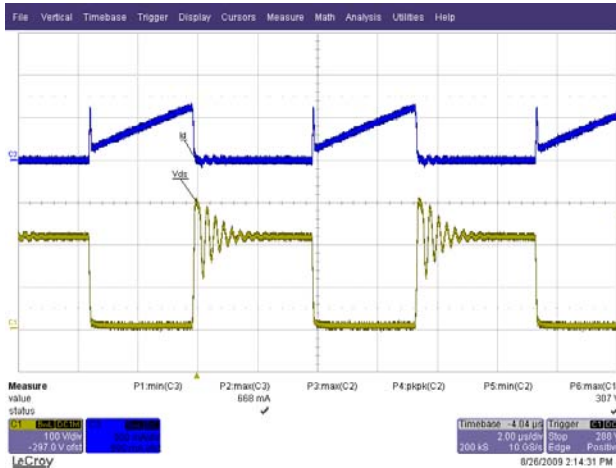

Figure 15 – 85 VAC, Full Load.
Upper: I_{DRAIN} , 0.5 A / div.
Lower: V_{DRAIN} , 100 V, 2 μs / div.

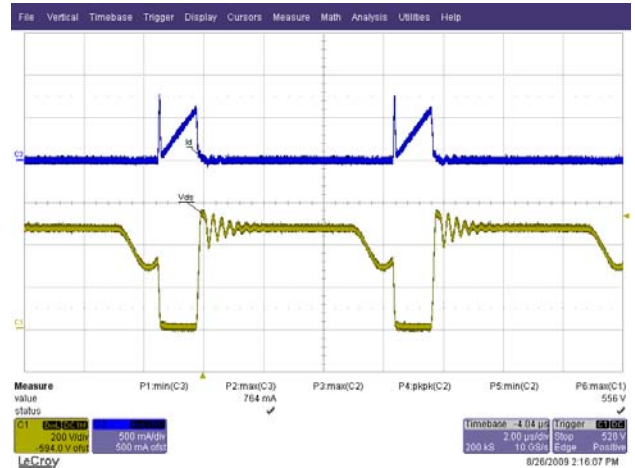

Figure 16 – 265 VAC, Full Load.
Upper: I_{DRAIN} , 0.5 A / div.
Lower: V_{DRAIN} , 200 V / div.

12.2 Output Voltage Start-up Profile

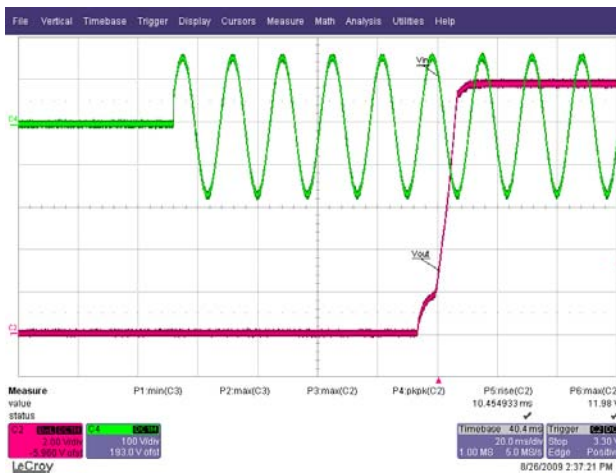

Figure 17 – Start-up Profile, 115 VAC,
20 ms / div.
Upper: V_{IN} , 100 V / div.
Lower: V_{OUT} , 2 V / div.

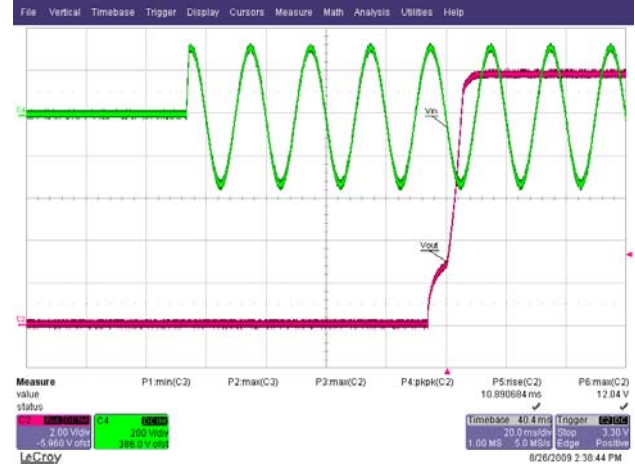

Figure 18 – Start-up Profile, 230 VAC,
20 ms / div.
Upper: V_{IN} , 200 V / div.
Lower: V_{OUT} , 2 V / div.



12.3 Drain Voltage and Current Start-up Profile

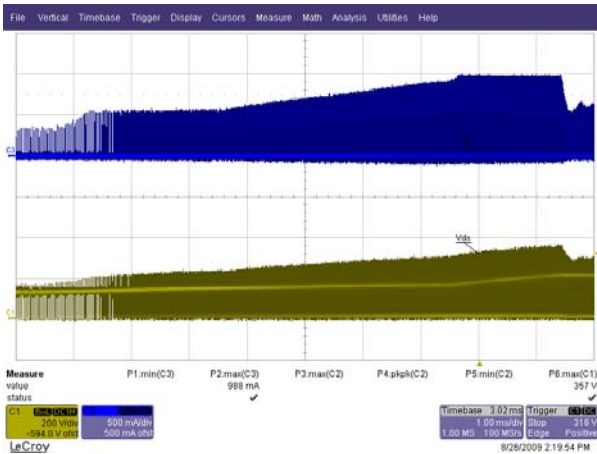

Figure 19 – 85 VAC Input and Maximum Load.
Upper: I_{DRAIN} , 0.5 A / div.
Lower: V_{DRAIN} , 100 V & 1 ms / div.

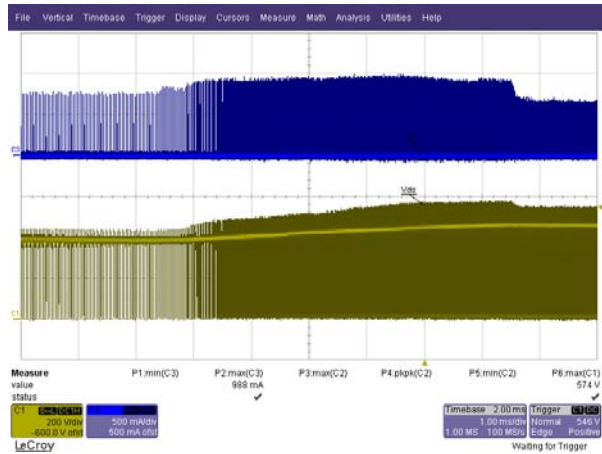

Figure 20 – 265 VAC Input and Maximum Load.
Upper: I_{DRAIN} , 0.5 A / div.
Lower: V_{DRAIN} , 200 V & 1 ms / div.

12.4 Load Transient Response (75% to 100% Load Step)

In the figures shown below, signal averaging was used to better enable viewing the load transient response. The oscilloscope was triggered using the load current step as a trigger source. Since the output switching and line frequency occur essentially at random with respect to the load transient, contributions to the output ripple from these sources will average out, leaving the contribution only from the load step response.

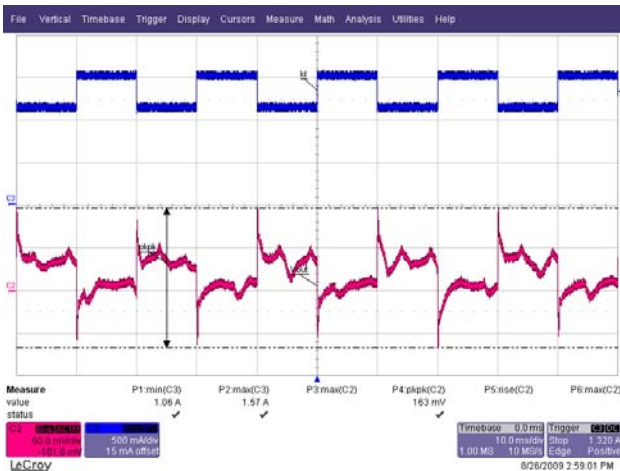

Figure 21 – Transient Response, 115 VAC,
75-100-75% Load Step.
Top: Load Current, 1 A / div.
Lower: Output Voltage
50 mV, 500 μ s / div.

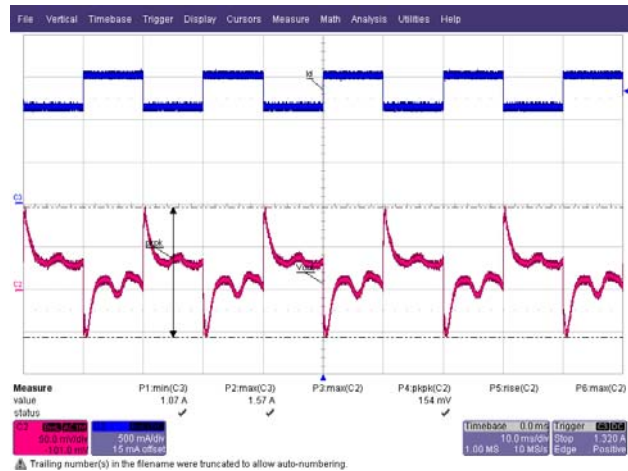

Figure 22 – Transient Response, 230 VAC,
75-100-75% Load Step.
Upper: Load Current, 1 A / div.
Lower: Output Voltage
50 mV, 2 ms / div.



12.5 Output Ripple Measurements

12.5.1 Ripple Measurement Technique

For DC output ripple measurements, a modified oscilloscope test probe must be utilized in order to reduce spurious signals due to pickup. Details of the probe modification are provided in the Figures below.

The 4987BA probe adapter is affixed with two capacitors tied in parallel across the probe tip. The capacitors include one (1) 0.1 $\mu\text{F}/50\text{ V}$ ceramic type and one (1) 1.0 $\mu\text{F}/50\text{ V}$ aluminum electrolytic. The aluminum electrolytic type capacitor is polarized, so proper polarity across DC outputs must be maintained (see below).

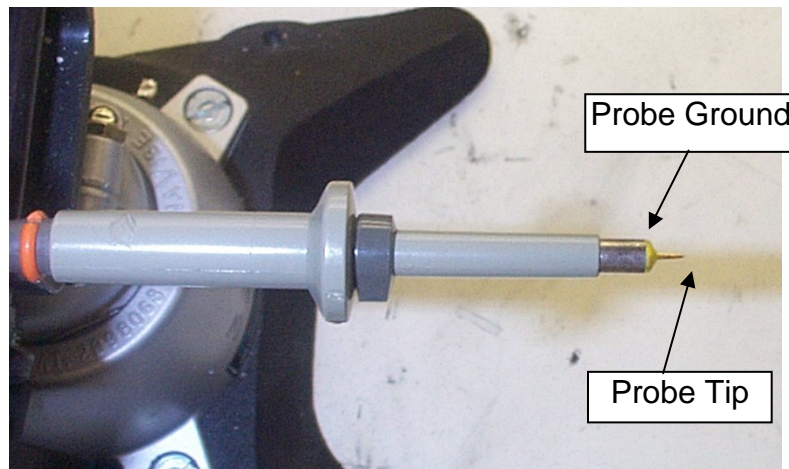

Figure 23 – Oscilloscope Probe Prepared for Ripple Measurement. (End Cap and Ground Lead Removed)



Figure 24 – Oscilloscope Probe with Probe Master (www.probemaster.com) 4987A BNC Adapter. (Modified with wires for ripple measurement, and two parallel decoupling capacitors added)

12.5.2 Measurement Results

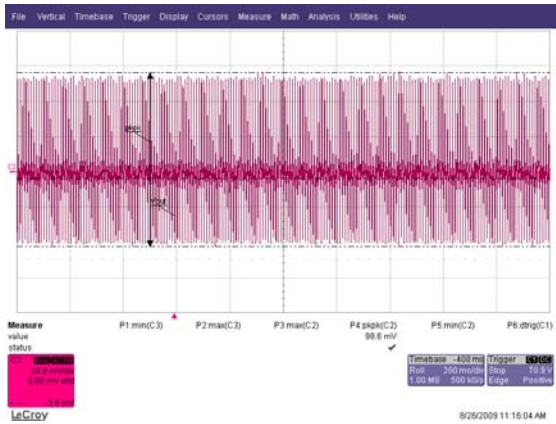

Figure 25 – Ripple [99 mV_{PP}], 90 VAC, Full Load. 200 ms, 20 mV / div.

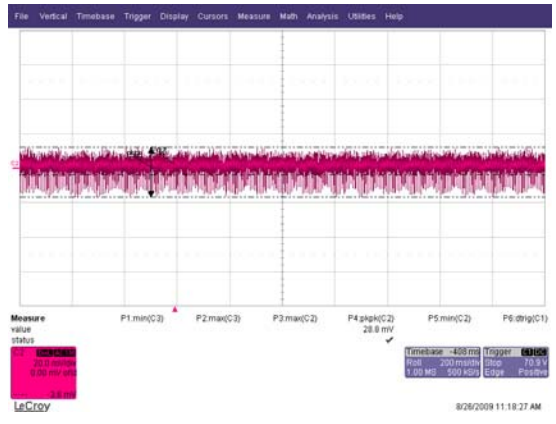

Figure 26 – 5 V Ripple [29 mV_{PP}], 115 VAC, Full Load. 200 ms, 20 mV / div.

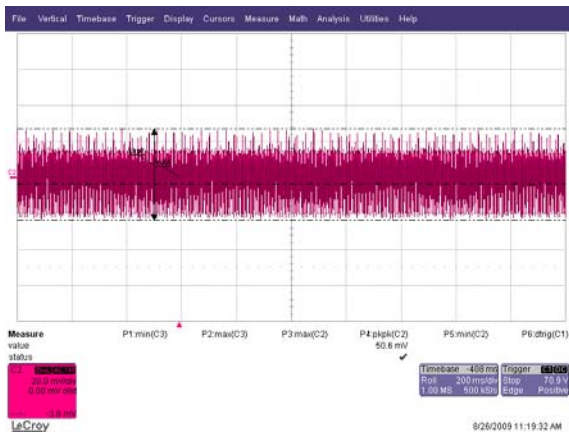

Figure 27 – Ripple [51 mV_{PP}], 230 VAC, Full Load. 200 ms, 20 mV / div.

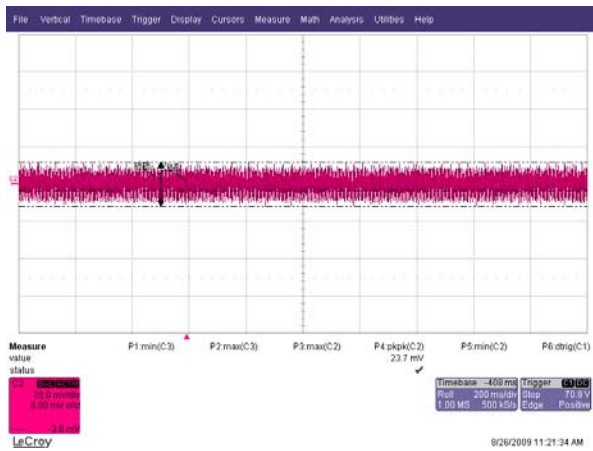

Figure 28 – Ripple [24 mV_{PP}], 265 VAC, Full Load. 200 ms, 20 mV / div.



13 Control Loop Measurements

Venable System equipment was used to gather this data.

13.1 115 VAC Maximum Load

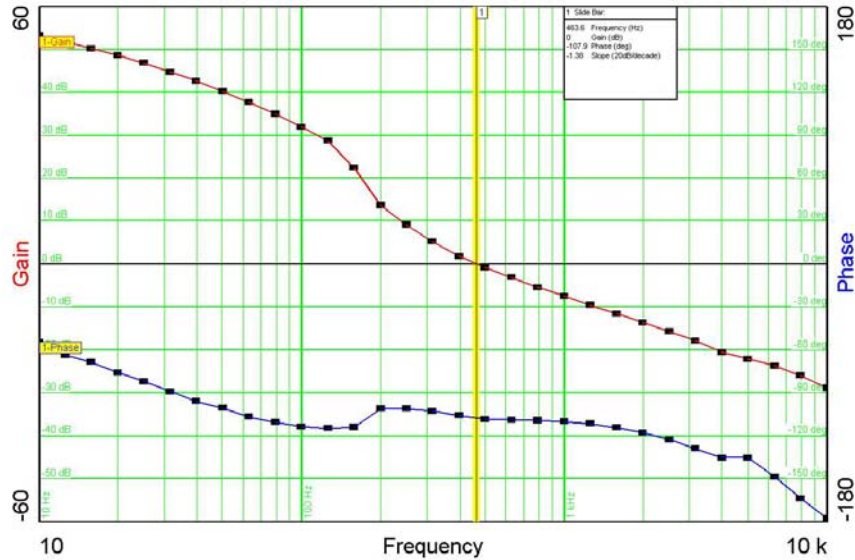

Figure 29 – Gain-Phase Plot, 180 VAC, Maximum Steady State Load.
 Vertical Scale: Gain = 10 dB / div, Phase = 30 °/ div.
 Crossover Frequency = 463 Hz Phase Margin = 72.1°

13.2 230 VAC Maximum Load

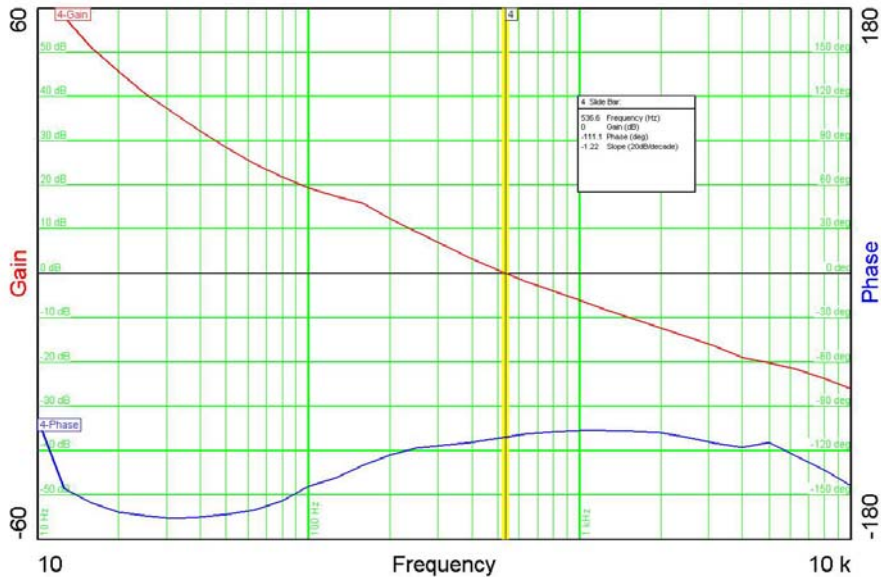

Figure 30 – Gain-Phase Plot, 230 VAC, Maximum Steady State Load.
 Vertical Scale: Gain = 10 dB / div, Phase = 50 °/ div.
 Crossover Frequency =536 Hz, Phase Margin = 68.9°



14 Conducted EMI

Equipment used: Rohde and Schwarz ESPI3 (PN: m1142.8007.03 / EMI Test Receiver 9 kHz to 3 GHz).

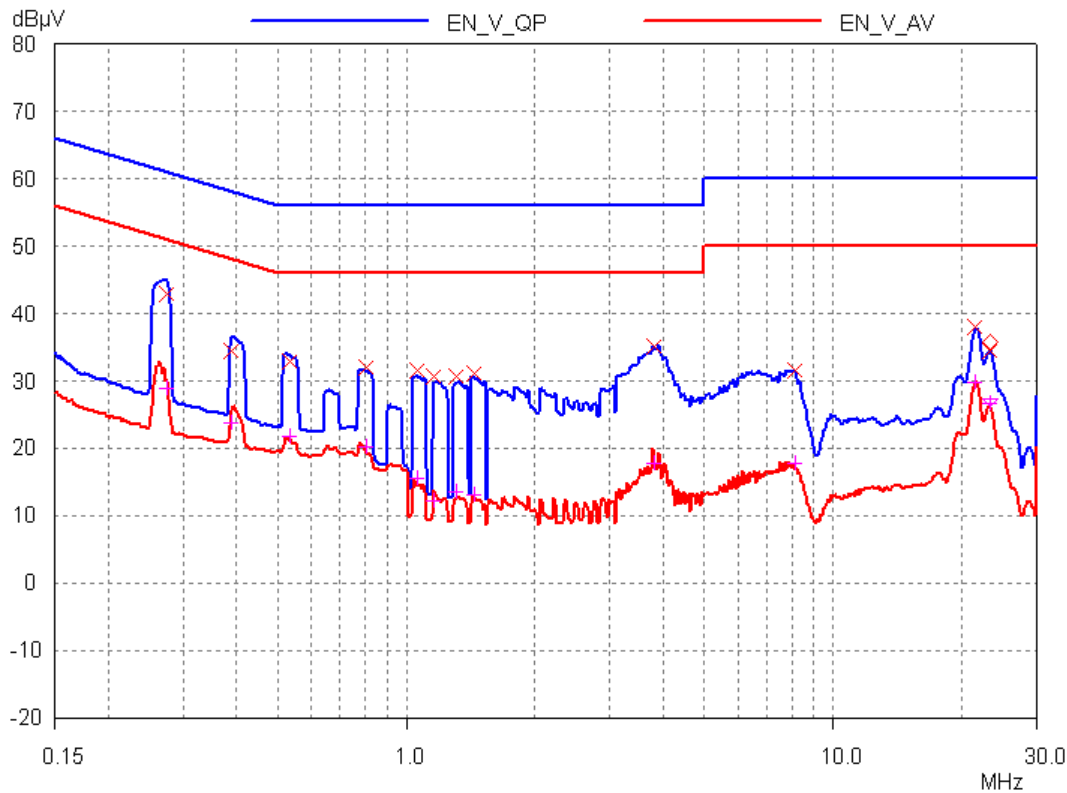

Figure 31 – Conducted EMI, Maximum Steady State Load, 115 VAC, 60 Hz, and EN5022 B Limits. Output Not Connected to PE (Floating).

Frequency MHz	Quasi Pk dBµV	Limit dBµV	Delta dB	Phase /PE	Average dBµV	Limit dBµV	Delta dB	Phase /PE
0.27484	42.84	60.97	18.13	L1/gnd	28.95	50.97	22.02	L1/gnd
0.38716	34.49	58.12	23.63	L1/gnd	23.83	48.12	24.29	L1/gnd
0.53249	33.00	56.00	23.00	L1/gnd	21.68	46.00	24.32	L1/gnd
0.80586	31.94	56.00	24.06	L1/gnd	20.24	46.00	25.76	L1/gnd
1.06507	31.46	56.00	24.54	L1/gnd	15.45	46.00	30.55	L1/gnd
1.16264	30.63	56.00	25.37	L1/gnd	12.12	46.00	33.88	L1/gnd
1.31025	30.64	56.00	25.36	L1/gnd	13.44	46.00	32.56	L1/gnd
1.44172	31.19	56.00	24.81	L1/gnd	13.15	46.00	32.85	L1/gnd
3.781	35.11	56.00	20.89	L1/gnd	17.82	46.00	28.18	L1/gnd
8.12489	31.47	60.00	28.53	N /gnd	17.82	50.00	32.18	N /gnd
21.47844	38.02	60.00	21.98	L1/gnd	29.77	50.00	20.23	N /gnd
23.25991	34.38	60.00	25.62	L1/gnd	26.64	50.00	23.36	N /gnd

Table 1 – Data for Figure 31.

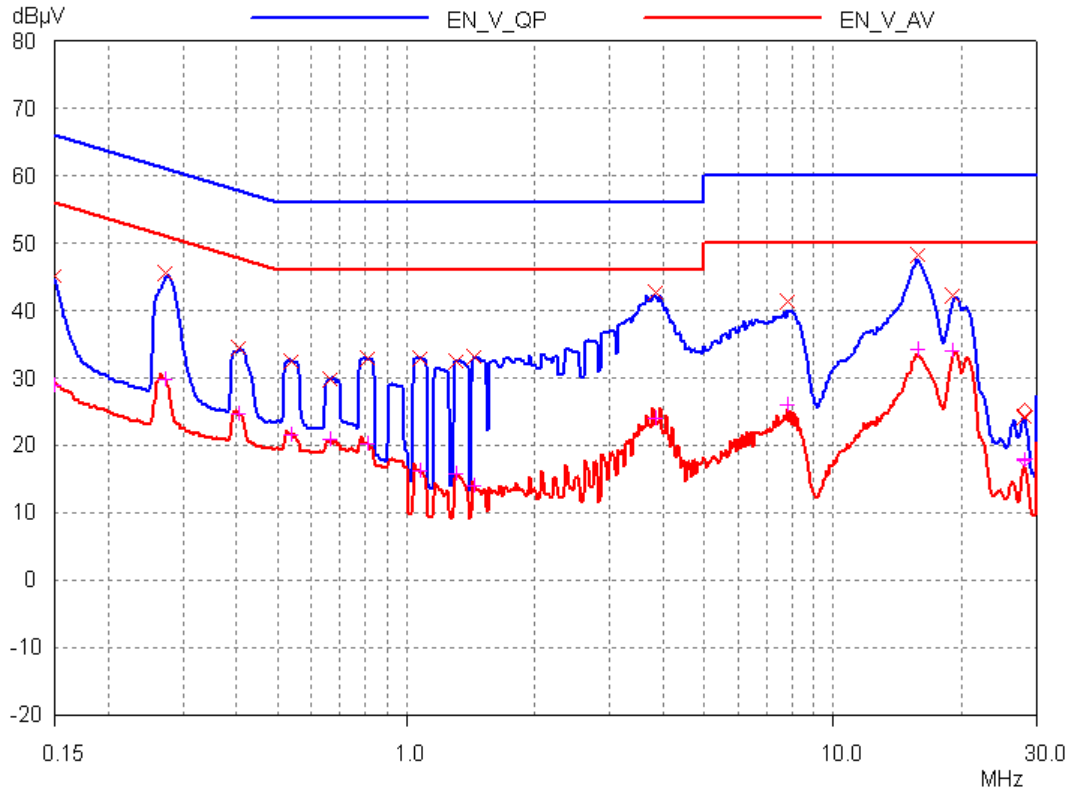

Figure 32 – Conducted EMI, Maximum Steady State Load, 115 VAC, 60 Hz, and EN55022 B Limits. Output Return Connected to PE.

Frequency MHz	Quasi Pk dBµV	Limit dBµV	Delta dB	Phase /PE	Average dBµV	Limit dBµV	Delta dB	Phase /PE
0.15	45.14	66.00	20.86	L1/gnd	28.90	56.00	27.10	L1/gnd
0.27266	45.64	61.04	15.40	L1/gnd	29.88	51.04	21.16	L1/gnd
0.40612	34.35	57.73	23.38	N /gnd	24.56	47.73	23.17	N /gnd
0.53675	32.41	56.00	23.59	L1/gnd	21.63	46.00	24.37	L1/gnd
0.66559	29.82	56.00	26.18	L1/gnd	20.84	46.00	25.16	N /gnd
0.81231	32.89	56.00	23.11	L1/gnd	20.11	46.00	25.89	L1/gnd
1.08218	32.99	56.00	23.01	L1/gnd	16.18	46.00	29.82	L1/gnd
1.31025	32.56	56.00	23.44	L1/gnd	15.67	46.00	30.33	N /gnd
1.44172	33.14	56.00	22.86	L1/gnd	13.90	46.00	32.10	L1/gnd
3.81124	42.60	56.00	13.40	L1/gnd	24.06	46.00	21.94	N /gnd
7.80755	41.34	60.00	18.66	N /gnd	25.94	50.00	24.06	N /gnd
15.74135	48.26	60.00	11.74	N /gnd	34.26	50.00	15.74	N /gnd
18.9075	42.26	60.00	17.74	N /gnd	34.00	50.00	16.00	N /gnd
27.93832	24.15	60.00	35.85	N /gnd	17.85	50.00	32.15	N /gnd

Table 2 – Data for Figure 32.



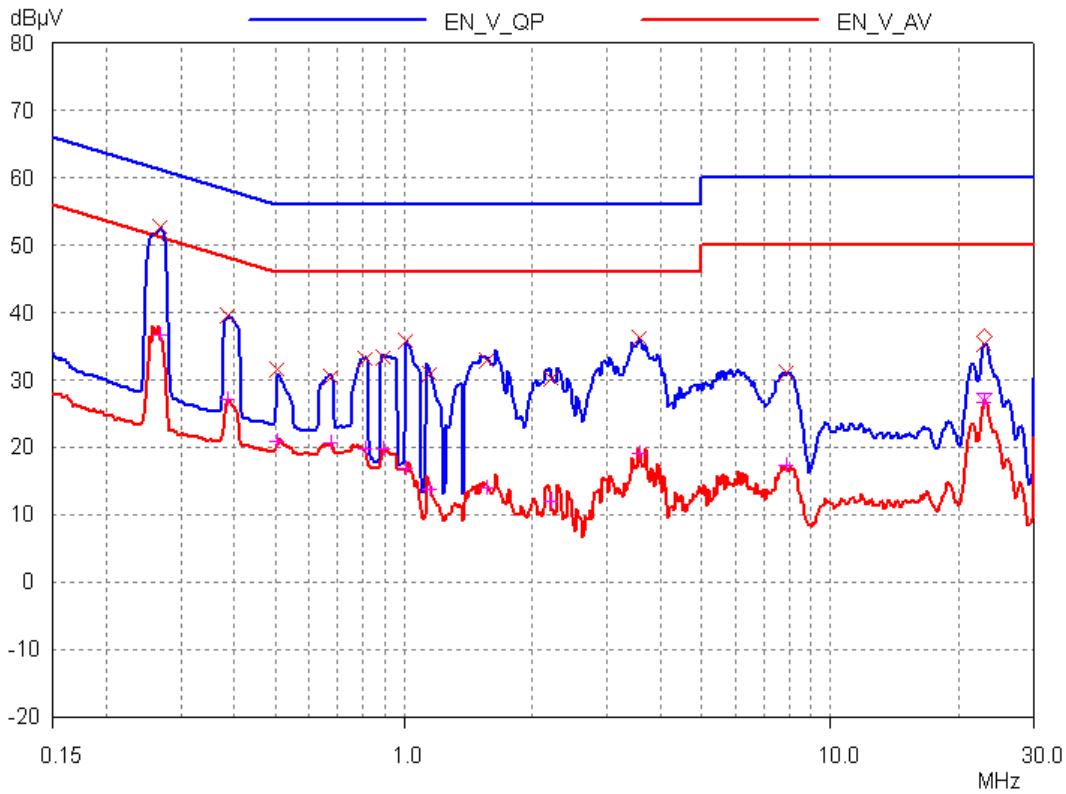

Figure 33 – Conducted EMI, Maximum Steady State Load, 230 VAC, 60 Hz, and EN55022 B Limits. Output Return Not Connected to PE (Floating).

Frequency MHz	Quasi Pk dBµV	Limit dBµV	Delta dB	Phase /PE	Average dBµV	Limit dBµV	Delta dB	Phase /PE
0.26835	52.60	61.17	8.57	L1/gnd	36.66	51.17	14.51	L1/gnd
0.38409	39.62	58.19	18.57	L1/gnd	27.05	48.19	21.14	L1/gnd
0.5036	31.61	56.00	24.39	L1/gnd	20.90	46.00	25.10	L1/gnd
0.67628	30.36	56.00	25.64	L1/gnd	20.56	46.00	25.44	L1/gnd
0.81231	33.04	56.00	22.96	L1/gnd	19.67	46.00	26.33	L1/gnd
0.89382	33.44	56.00	22.56	L1/gnd	19.67	46.00	26.33	L1/gnd
1.00729	35.73	56.00	20.27	L1/gnd	16.86	46.00	29.14	L1/gnd
1.15342	30.91	56.00	25.09	L1/gnd	13.81	46.00	32.19	L1/gnd
1.5613	32.97	56.00	23.03	L1/gnd	13.93	46.00	32.07	L1/gnd
2.19933	30.21	56.00	25.79	L1/gnd	11.94	46.00	34.06	L1/gnd
3.5475	36.15	56.00	19.85	L1/gnd	19.18	46.00	26.82	L1/gnd
7.87001	31.18	60.00	28.82	N /gnd	17.22	50.00	32.78	N /gnd
22.89217	35.37	60.00	24.63	L1/gnd	26.68	50.00	23.32	N /gnd

Table 3 – Data for Figure 33.



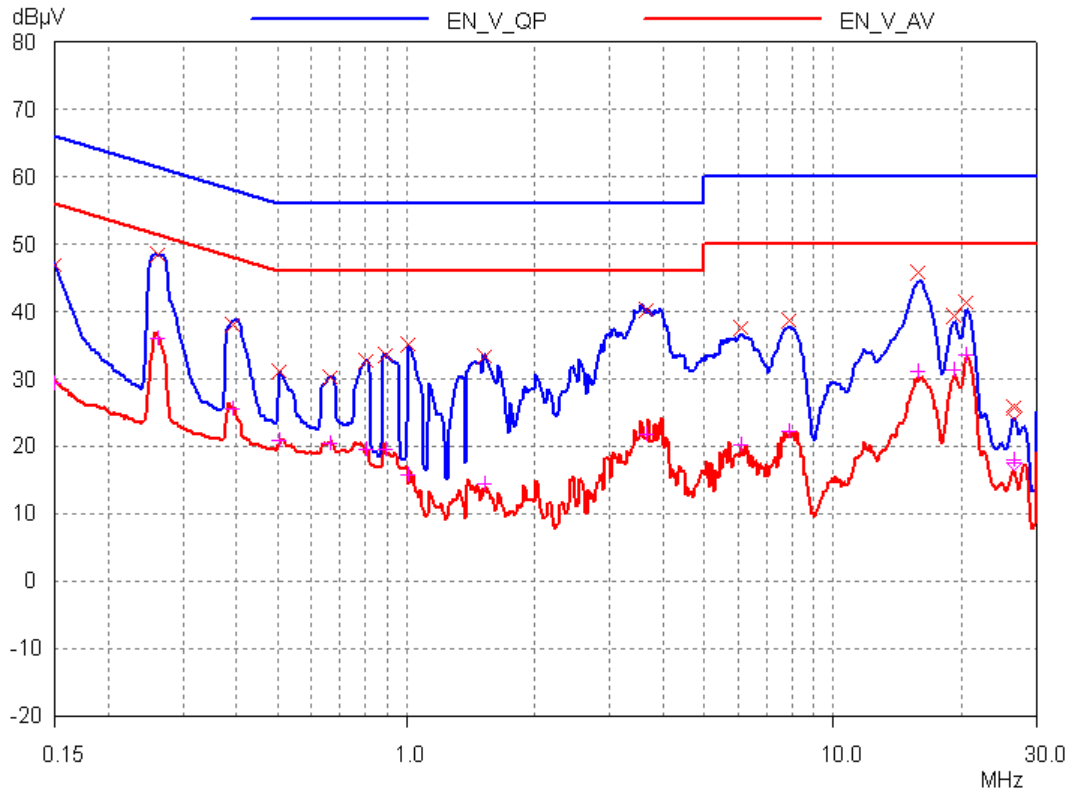

Figure 34 – Conducted EMI, Maximum Steady State Load, 230 VAC, 60 Hz, and EN55022 B Limits. Output Return Connected to PE.

Frequency MHz	Quasi Pk dBµV	Limit dBµV	Delta dB	Phase /PE	Average dBµV	Limit dBµV	Delta dB	Phase /PE
0.15	46.93	66.00	19.07	L1/gnd	29.25	56.00	26.75	L1/gnd
0.26201	48.53	61.37	12.84	N /gnd	35.90	51.37	15.47	L1/gnd
0.39026	38.05	58.06	20.01	L1/gnd	25.44	48.06	22.62	L1/gnd
0.5036	31.13	56.00	24.87	L1/gnd	20.77	46.00	25.23	L1/gnd
0.66559	30.16	56.00	25.84	L1/gnd	20.49	46.00	25.51	L1/gnd
0.80586	32.67	56.00	23.33	L1/gnd	19.60	46.00	26.40	L1/gnd
0.89382	33.46	56.00	22.54	L1/gnd	19.60	46.00	26.40	L1/gnd
1.00729	35.09	56.00	20.91	L1/gnd	15.80	46.00	30.20	L1/gnd
1.52442	33.36	56.00	22.64	L1/gnd	14.37	46.00	31.63	L1/gnd
3.63332	40.24	56.00	15.76	L1/gnd	21.70	46.00	24.30	N /gnd
6.05031	37.60	60.00	22.40	N /gnd	20.22	50.00	29.78	N /gnd
7.87001	38.57	60.00	21.43	N /gnd	22.30	50.00	27.70	N /gnd
15.74135	45.79	60.00	14.21	N /gnd	31.02	50.00	18.98	N /gnd
19.21123	39.40	60.00	20.60	N /gnd	31.30	50.00	18.70	N /gnd
20.47573	41.29	60.00	18.71	N /gnd	33.54	50.00	16.46	N /gnd
26.42266	25.77	60.00	34.23	N /gnd	17.89	50.00	32.11	N /gnd

Table 4 – Data for Figure 34.



15 Radiated EMI

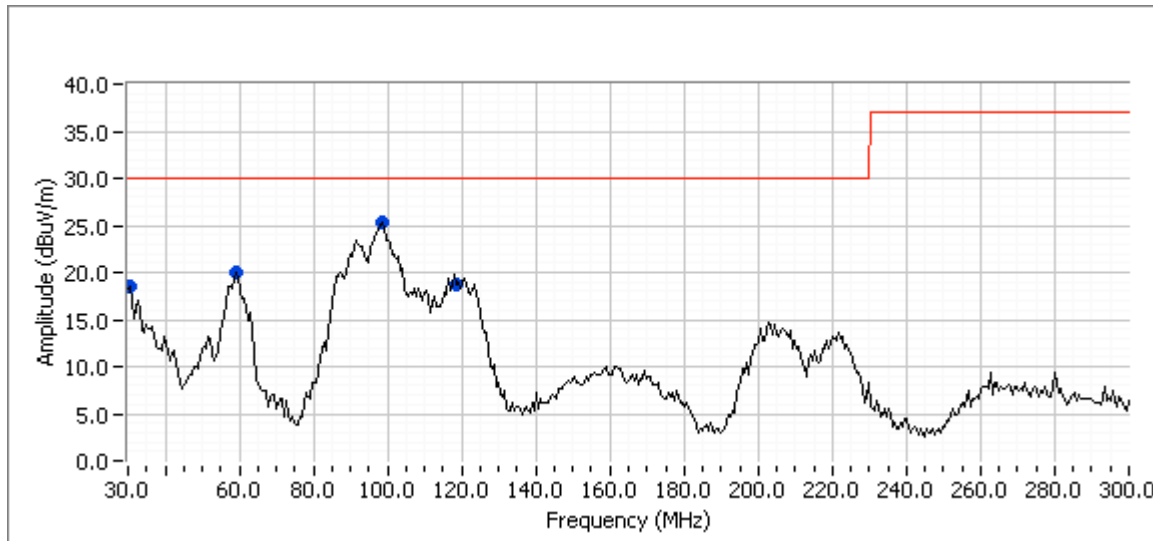

Frequency	Level	Pol	EN55022 Class B		Detector	Azimuth	Height
MHz	dB μ V/m	v/h	Limit	Margin	PK/QP/AVE	Degrees	Meters
99.442	25.3	V	30.0	-4.7	Peak	237	1.0
99.442	23.1	V	30.0	-6.9	QP	219	1.0
59.218	20.0	V	30.0	-10.0	Peak	197	1.0
118.737	18.8	V	30.0	-11.2	Peak	123	1.0
30.541	18.6	V	30.0	-11.4	Peak	37	1.0

Figure 35 – Radiated EMI, Maximum Steady State Load, 120 VAC, 50 Hz, and EN55022 B Limits.



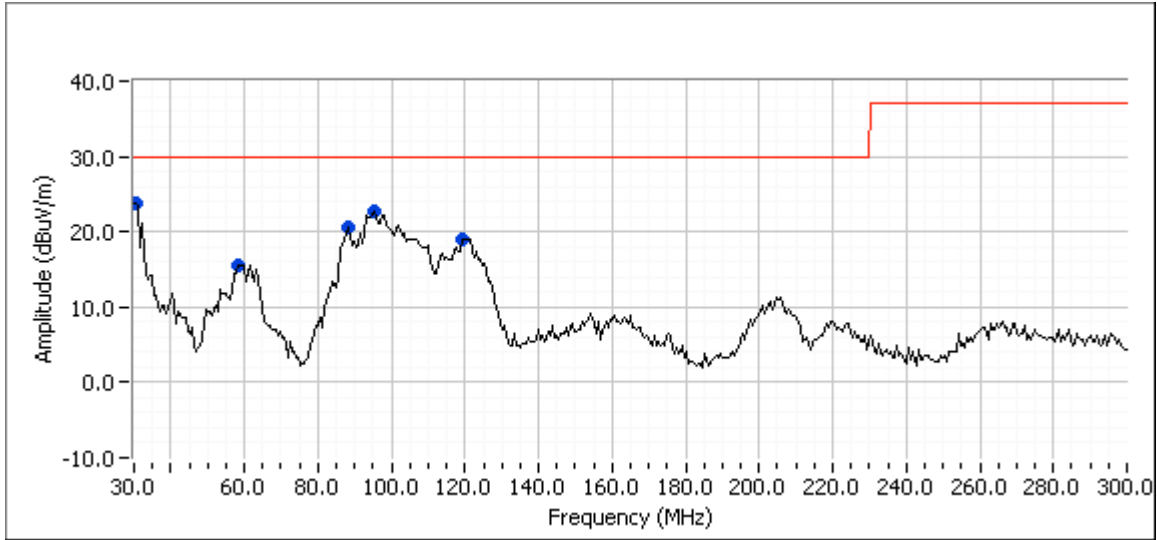

Frequency MHz	Level dBµV/m	Pol v/h	EN55022 Class B		Detector Pk/QP/Avg	Azimuth Degrees	Height Meters
			Limit	Margin			
30.923	23.9	V	30.0	-6.1	Peak	332	1.0
30.923	21.2	V	30.0	-8.8	QP	223	1.0
95.471	22.7	V	30.0	-7.3	Peak	269	1.0
88.437	20.6	H	30.0	-9.4	Peak	246	4.0
119.279	19.0	V	30.0	-11.0	Peak	177	1.0
58.136	15.4	V	30.0	-14.6	Peak	11	3.0

Figure 36 – Radiated EMI, Maximum Steady State Load, 230 VAC, 60 Hz, and EN55022 B Limits.



16 Revision History

Date	Author	Revision	Description & changes	Reviewed
17-Sep-09	JDC	1.0	Initial Release	Apps & Mktg



For the latest updates, visit our website: www.powerint.com

Power Integrations reserves the right to make changes to its products at any time to improve reliability or manufacturability. Power Integrations does not assume any liability arising from the use of any device or circuit described herein. POWER INTEGRATIONS MAKES NO WARRANTY HEREIN AND SPECIFICALLY DISCLAIMS ALL WARRANTIES INCLUDING, WITHOUT LIMITATION, THE IMPLIED WARRANTIES OF MERCHANTABILITY, FITNESS FOR A PARTICULAR PURPOSE, AND NON-INFRINGEMENT OF THIRD PARTY RIGHTS.

PATENT INFORMATION

The products and applications illustrated herein (including transformer construction and circuits external to the products) may be covered by one or more U.S. and foreign patents, or potentially by pending U.S. and foreign patent applications assigned to Power Integrations. A complete list of Power Integrations' patents may be found at www.powerint.com. Power Integrations grants its customers a license under certain patent rights as set forth at <http://www.powerint.com/ip.htm>.

The PI Logo, TOPSwitch, TinySwitch, LinkSwitch, DPA-Switch, PeakSwitch, EcoSmart, Clampless, E-Shield, Filterfuse, StackFET, PI Expert and PI FACTS are trademarks of Power Integrations, Inc. Other trademarks are property of their respective companies. ©Copyright 2009 Power Integrations, Inc.

Power Integrations Worldwide Sales Support Locations

WORLD HEADQUARTERS

5245 Hellyer Avenue
San Jose, CA 95138, USA.
Main: +1-408-414-9200
Customer Service:
Phone: +1-408-414-9665
Fax: +1-408-414-9765
e-mail:
usasales@powerint.com

GERMANY

Rueckertstrasse 3
D-80336, Munich
Germany
Phone: +49-89-5527-3911
Fax: +49-89-5527-3920
e-mail:
eurossales@powerint.com

JAPAN

Kosei Dai-3 Building
2-12-11, Shin-Yokohama,
Kohoku-ku, Yokohama-shi,
Kanagawa 222-0033
Japan
Phone: +81-45-471-1021
Fax: +81-45-471-3717
e-mail: japansales@powerint.com

TAIWAN

5F, No. 318, Nei Hu Rd., Sec. 1
Nei Hu District
Taipei 114, Taiwan R.O.C.
Phone: +886-2-2659-4570
Fax: +886-2-2659-4550
e-mail:
taiwansales@powerint.com

CHINA (SHANGHAI)

Rm 1601/1610, Tower 1
Kerry Everbright City
No. 218 Tianmu Road West
Shanghai, P.R.C. 200070
Phone: +86-021-6354-6323
Fax: +86-021-6354-6325
e-mail:
chinasales@powerint.com

INDIA

#1, 14th Main Road
Vasanthanagar
Bangalore-560052
India
Phone: +91-80-4113-8020
Fax: +91-80-4113-8023
e-mail:
indiasales@powerint.com

KOREA

RM 602, 6FL
Korea City Air Terminal B/D, 159-6
Samsung-Dong, Kangnam-Gu,
Seoul, 135-728
Korea
Phone: +82-2-2016-6610
Fax: +82-2-2016-6630
e-mail: koreasales@powerint.com

UNITED KINGDOM

1st Floor, St. James's House
East Street,
Farnham Surrey, GU9 7TJ
United Kingdom
Phone: +44 (0) 1252-730-141
Fax: +44 (0) 1252-727-689
e-mail:
eurossales@powerint.com

CHINA (SHENZHEN)

Rm A, B & C 4th Floor, Block C,
Electronics Science and
Technology Building
2070 Shennan Zhong Road
Shenzhen, Guangdong,
P.R.C. 518031
Phone: +86-755-8379-3243
Fax: +86-755-8379-5828
e-mail:
chinasales@powerint.com

ITALY

Via De Amicis 2
20091 Bresso MI
Italy
Phone: +39-028-928-6000
Fax: +39-028-928-6009
e-mail:
eurossales@powerint.com

SINGAPORE

51 Newton Road,
#15-08/10 Goldhill Plaza
Singapore, 308900
Phone: +65-6358-2160
Fax: +65-6358-2015
e-mail:
singaporesales@powerint.com

APPLICATIONS HOTLINE

World Wide +1-408-414-9660

APPLICATIONS FAX

World Wide +1-408-414-9760

